

www.angiotech.com

SPECIALTIES SUTURES CATALOG

SHARPOINT™/LOOK™

SPECIALTIES SUTURES CATALOG

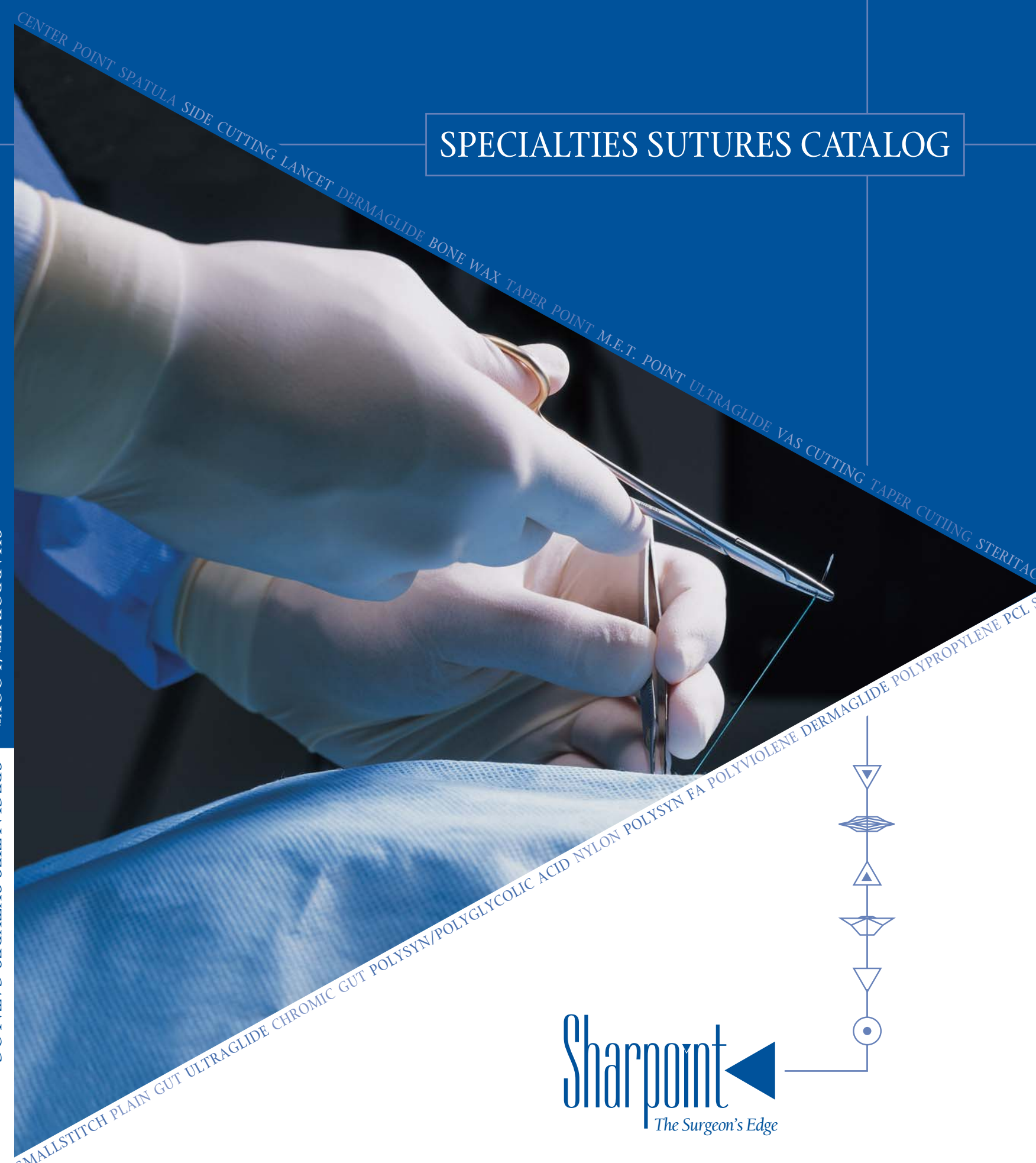

Surgical Specialties Corporation, 100 Dennis Drive, Reading, PA 19606, U.S.A.
 732 626-6466 • 877 991-1110 (U.S.A. and Canada only) • Fax: 610 404-4010
 www.angiotech.com • info@angiotech.com
 #WCG-PM-048R3 6/08

SharpPoint™, LOOK™, UltraGlide™, DermaGlide™, Monoderm™, PolySyn™, PolySynFA™, Polyviolene™, M.E.T.™, SmallStitch™, PracticePak™, PracticeRat™ are trademarks of Surgical Specialties Corporation.

© 2008 Angiotech Pharmaceuticals, Inc. © 2008 Surgical Specialties Corporation
 All Rights Reserved.



www.angiotech.com

877 991-1110 • 732 626-6466



When you depend upon the quality and effectiveness of the suture in your hand, Sharpoint is a name you can trust. Our proprietary manufacturing process gives us complete control over the quality of every needle that we sell. We set new industry standards with our DermaGlide™ and UltraGlide™ tip geometry. For over thirty years, the Sharpoint name has been synonymous with providing the highest quality needles and sutures to the microsurgical, dermatologic, plastic and ophthalmic communities.

LOOK began manufacturing sutures in the United States in 1936. In its early days, LOOK supplied sutures to prestigious institutions such as MIT and Harvard University. In 1996, LOOK merged with Surgical Specialties Corporation, a world-class manufacturer and innovator. Today, LOOK brand sutures continue to meet the demand of the newest techniques in office surgery, as well as dental and cardiovascular procedures.

In March 2006, Angiotech Pharmaceuticals, Inc. completed the acquisition of American Medical Instrument Holdings, Inc., which was a leading independent manufacturer of specialty, single-use medical devices that included both Sharpoint™ and LOOK™ brand products. Angiotech Pharmaceuticals, Inc. is a specialty pharmaceutical company that discovers and develops innovative treatment solutions for diseases or complications associated with medical device implants, surgical interventions and acute injury or trauma.

This catalog represents all of our ISO Certified Sharpoint™ and LOOK™ wound closure products in one comprehensive resource, and we back up our products with the highest level of customer service found in the industry.

We are always interested in your feedback and new product ideas. Your comments let us continue to expand and improve the products you've come to trust for quality and cutting-edge technology.

www.angiotech.com

Angiotech

100 Dennis Drive, Reading, PA 19606 U.S.A.
732 626-6466 • 877 991-1110 • Fax 610 404-4010



TABLE OF CONTENTS

Introduction

How to Use This Catalog.....	5
Suture Materials.....	6
Needle Charts.....	7

Absorbable Sutures

Plain Gut.....	11
Chromic Gut.....	13
PolySyn FA™.....	17
PolySyn™/PolyGlycolic Acid.....	19
Monoderm™.....	27
PCL.....	29

Nonabsorbable Sutures

Polyviolene™.....	33
Nylon.....	35
Silk.....	45
Polypropylene.....	51

Additional Products

Additional Products.....	57
--------------------------	----

Product Index

Product Index.....	61
--------------------	----

If you would like to place an order or require assistance cross-referencing one of our products, please call 877 991-1110 or 732 626-6466 and ask for our Customer Service Team.

INTRODUCTION

INTRODUCTION

...L
...AGL
...AS CUTTI
...ON POLYSYN
...X TAPER POINT M.
...POLYSYN/POLYGLYCO
...CUTTING LANCET DERMAGL
...LAIN GUT ULTRAGLIDE CHROM
...CUTTING CENTER POINT SPATULA S
...GHT CUTTING STERITAC SILK SMALLSTIT
...AGLIDE POLYPROPYLENE PCL REVERSE CUTTI
...LIDE VAS CUTTING TAPER CUTTING STRAIGHT CUTTI
...OLYSYN FA POLYVIOLENE DERMAGLIDE POLYPROPYLE
...POINT M.E.T. POINT ULTRAGLIDE VAS CUTTING TAPER CUTTI
...OLYSYN/POLYGLYCOLIC ACID NYLON POLYSYN FA POLYVIOLE
...LANCET DERMAGLIDE BONEWAX TAPER POINT M.E.T. POINT ULTRAGL
...GUT ULTRAGLIDE CHROMIC GUT POLYSYN/POLYGLYCOLIC ACID NYL
...G CENTER POINT SPATULA SIDE CUTTING LANCET DERMAGLIDE BONEWAX TAP
...GHT CUTTING STERITAC SILK SMALLSTITCH PLAIN GUT ULTRAGLIDE CHROMIC C
...MAGLIDE POLYPROPYLENE PCL REVERSE CUTTING CENTER POINT SPATULA SIDE CUTTI
...GLIDE VAS CUTTING TAPER CUTTING STRAIGHT CUTTING STERITAC SMALLSTITCH PLAIN C
...LON POLYSYN FA POLYVIOLENE DERMAGLIDE POLYPROPYLENE PCL REVERSE CUTTING CEN
...AX TAPER POINT M.E.T. POINT ULTRAGLIDE VAS CUTTING TAPER CUTTING STRAIGHT CUTTING STERIT
...GUT POLYSYN/POLYGLYCOLIC ACID NYLON POLYSYN FA POLYVIOLENE DERMAGLIDE POLYPROPYLE
...CUTTING LANCET DERMAGLIDE BONEWAX TAPER POINT M.E.T. POINT ULTRAGLIDE VAS CUTTING TAPER CUTTI
...TCH PLAIN GUT ULTRAGLIDE CHROMIC GUT POLYSYN/POLYGLYCOLIC ACID NYLON POLYSYN FA POLYVIOLE
...SE CUTTING CENTER POINT SPATULA SIDE CUTTING LANCET DERMAGLIDE BONEWAX TAPER POINT M.E.T. POINT ULTRAGL
...GHT CUTTING STERITAC SILK SMALLSTITCH PLAIN GUT ULTRAGLIDE CHROMIC GUT POLYSYN/POLYGLYCOLIC ACID NYL
...MAGLIDE POLYPROPYLENE PCL REVERSE CUTTING CENTER POINT SPATULA SIDE CUTTING LANCET DERMAGLIDE BONEWAX TAP
...ENT ULTRAGLIDE VAS CUTTING TAPER CUTTING STRAIGHT CUTTING STERITAC SMALLSTITCH PLAIN GUT ULTRAGLIDE CHROMIC C
...C ACID NYLON POLYSYN FA POLYVIOLENE DERMAGLIDE POLYPROPYLENE PCL REVERSE CUTTING CENTER POINT SPATULA SIDE CUTTI
...E BONEWAX TAPER POINT M.E.T. POINT ULTRAGLIDE VAS CUTTING TAPER CUTTING STRAIGHT CUTTING STERITAC SILK SMALLSTITCH PLAIN C
...MOMIC GUT POLYSYN/POLYGLYCOLIC ACID NYLON POLYSYN FA POLYVIOLENE DERMAGLIDE POLYPROPYLENE PCL REVERSE CUTTING CEN
...ULA SIDE CUTTING LANCET DERMAGLIDE BONEWAX TAPER POINT M.E.T. POINT ULTRAGLIDE VAS CUTTING TAPER CUTTING STRAIGHT CUTTING STERIT
...LSTITCH PLAIN GUT ULTRAGLIDE CHROMIC GUT POLYSYN/POLYGLYCOLIC ACID NYLON POLYSYN FA POLYVIOLENE DERMAGLIDE POLYPROPYLENE PCL REVERSE CUTTING CEN
...TAPER CUTTING CENTER POINT SPATULA SIDE CUTTING LANCET DERMAGLIDE BONEWAX TAPER POINT M.E.T. POINT ULTRAGLIDE VAS CUTTING TAPER CUTTI
...GHT CUTTING STERITAC SILK SMALLSTITCH PLAIN GUT ULTRAGLIDE CHROMIC GUT POLYSYN/POLYGLYCOLIC ACID NYLON POLYSYN FA POLYVIOLE
...POLYPROPYLENE PCL REVERSE CUTTING CENTER POINT SPATULA SIDE CUTTING LANCET DERMAGLIDE BONEWAX TAPER POINT M.E.T. POINT ULTRAGL
...TAPER CUTTING STRAIGHT CUTTING STERITAC SMALLSTITCH PLAIN GUT ULTRAGLIDE CHROMIC GUT POLYSYN/POLYGLYCOLIC ACID NYL
...FINE DERMAGLIDE POLYPROPYLENE PCL REVERSE CUTTING CENTER POINT SPATULA SIDE CUTTING LANCET DERMAGLIDE BONEWAX TAP
...ULTRAGLIDE VAS CUTTING TAPER CUTTING STRAIGHT CUTTING STERITAC SILK SMALLSTITCH PLAIN GUT ULTRAGLIDE CHROMIC C
...NYLON POLYSYN FA POLYVIOLENE DERMAGLIDE POLYPROPYLENE PCL REVERSE CUTTING CENTER POINT SPATULA SIDE CUTTI
...TAPER POINT M.E.T. POINT ULTRAGLIDE VAS CUTTING TAPER CUTTING STRAIGHT CUTTING STERITAC SMALLSTITCH PLAIN C
...POLYGLYCOLIC ACID NYLON POLYSYN FA POLYVIOLENE DERMAGLIDE POLYPROPYLENE PCL REVERSE CUTTING CEN
...MAGLIDE BONEWAX TAPER POINT M.E.T. POINT ULTRAGLIDE VAS CUTTING TAPER CUTTING STRAIGHT CUTTING STERIT
...MOMIC GUT POLYSYN/POLYGLYCOLIC ACID NYLON POLYSYN FA POLYVIOLENE DERMAGLIDE POLYPROPYLE
...CUTTING LANCET DERMAGLIDE BONEWAX TAPER POINT M.E.T. POINT ULTRAGLIDE VAS CUTTING TAPER CUTTI
...GUT ULTRAGLIDE CHROMIC GUT POLYSYN/POLYGLYCOLIC ACID NYLON POLYSYN FA POLYVIOLE
...POINT SPATULA SIDE CUTTING LANCET DERMAGLIDE BONEWAX TAPER POINT M.E.T. POINT ULTRAGL
...SMALLSTITCH PLAIN GUT ULTRAGLIDE CHROMIC GUT POLYSYN/POLYGLYCOLIC ACID NYL
...SE CUTTING CENTER POINT SPATULA SIDE CUTTING LANCET DERMAGLIDE BONEWAX TAP
...STRAIGHT CUTTING STERITAC SMALLSTITCH PLAIN GUT ULTRAGLIDE CHROMIC C
...POLYPROPYLENE PCL REVERSE CUTTING CENTER POINT SPATULA SIDE CUTTI
...TAPER CUTTING STRAIGHT CUTTING STERITAC SILK SMALLSTITCH PLAIN C
...VIOLENE DERMAGLIDE POLYPROPYLENE PCL REVERSE CUTTING CEN
...MAGLIDE VAS CUTTING TAPER CUTTING STRAIGHT CUTTING STERIT
...POLYSYN FA POLYVIOLENE DERMAGLIDE POLYPROPYLENE PCL REVERSE CUTTING CEN
...NT M.E.T. POINT ULTRAGLIDE VAS CUTTING TAPER CUTTI
...YGLYCOLIC ACID NYLON POLYSYN FA POLYVIOLE
...BONEWAX TAPER POINT M.E.T. POINT ULTRAGL
...GUT POLYSYN/POLYGLYCOLIC ACID NYL
...G LANCET DERMAGLIDE BONEWAX TAP
...IN GUT ULTRAGLIDE CHROMIC C
...TAPER POINT SPATULA SIDE CUTTI
...C SMALLSTITCH PLAIN C
...RSE CUTTING CEN
...CUTTING STERIT
...POLYPROPYLE
...P CUTTI
...OLE

INTRODUCTION

HOW TO USE OUR CATALOG

The pages in the suture sections of this catalog will show the following information for each product code. Our ophthalmic products feature an expanded chart with detailed measurements (not shown in this sample) to ensure proper needle selection.

Description - Picture of the actual needle. The SharpPoint™ needle code is blue, LOOK™ needle code is purple, and Ethicon code is in parenthesis. Also lists needle length and shape.

Needle Geometry - Type of needle with cross section reference.

Material - Color and style of suture.

Length - Length in inches. Also indicates the number of strands per package, if more than one.

Size Grid - Indicates the U.S.P. size for each product code listed.

NEEDLE	MATERIAL	LENGTH	SIZE				
			6-0	5-0	4-0	3-0	
 DSM18 PC31 18.00mm 3/8 Circle (PS-2)	Black Braided	18"/45cm		DA-2186N ■ 1676G	DA-2187N 1270B 1677G		

SharpPoint™ product code
LOOK™ product code
Ethicon equivalent

MATERIALS CHART - This chart shows leading manufacturers' material names.

SharpPoint™/Look™	Ethicon	USS	Material
Plain Gut	Surgical Gut	SurgiGut™	Natural Absorbable Gut
Chromic Gut	Surgical Gut	SurgiGut™	Natural Absorbable Gut
PolySyn FA™	Vicryl Rapide™ (Coated)	————	Coated, Braided Synthetic Absorbable
PolySyn™/PGA	Vicryl™ (Coated)	Polysorb™	Coated, Braided Synthetic Absorbable
Monoderm™	Monocryl™	Caprosyn™/Biosyn™	Coated, Monofilament Synthetic Absorbable
PCL	PDS II™	Maxon™	Monofilament, Synthetic Absorbable
Polyviolene™	Mersilene™ (Uncoated) Ethibond™ (Coated)	Surgidac™/Ti-Cron™	Non-Absorbable, Coated/Braided Polyester
Nylon	Ethilon™	Monosof™/Dermalon™	Non-Absorbable, Monofilament Nylon
Silk	Permahand Silk™ (Coated)	Sofsilk™	Non-Absorbable, Coated/Braided Silk
Polypropylene	Prolene™	Surgipro™/Surgilene™	Non-Absorbable, Monofilament

SUTURE MATERIALS

High-quality, consistently sharp needles.

- ▶ Extra sharp cutting edges extending from the point to its widest portion reduce tissue drag.
- ▶ Precise, smooth penetration through tissue minimizes trauma.
- ▶ Needle channel is fitted to the specific size of the suture material.

Absorbables

PolySyn™/Polyglycolic Acid

The extraordinarily smooth, low friction proprietary coating reduces tissue drag. These synthetic absorbable sutures ensure closure through the critical wound healing period. They retain approximately 50% of their high initial strength at two weeks and 20% of their strength at three weeks. Available as undyed or violet braided and violet monofilament.



SharpPoint™ PolySyn FA™

Developed for short-term closures, SharpPoint PolySyn FA is ideal for skin and mucosa closings that may benefit from fast suture absorption. An undyed, braided Polyglycolic Acid (PGA) suture, it maintains 40% strength at 7 days, 0% at 14-17 days and is essentially absorbed at 49-63 days. It is processed to absorb quickly with little tissue reaction.

SharpPoint™ Monoderm™

This synthetic absorbable monofilament has excellent pliability and handling characteristics. At 7 days it retains 64-76% tensile strength, 40% at 14 days and is essentially absorbed at 90 days. These characteristics make it very popular for subcuticular closure and soft tissue approximation. Available in undyed/clear or violet.



SharpPoint™ PCL

This absorbable monofilament features a pliable construction with extended wound support. It retains approximately 82% of its high tensile strength at two weeks and 77% of its strength at three weeks. Complete absorption occurs as early as 180 days. It elicits minimal inflammatory tissue reactivity to be considered nonirritating. Available in clear or dyed violet.

Non-Absorbables

Polyviolene™/Braided Polyester

The fine braiding of Polyester gives this material an excellent smoothness. Easy to handle, its uniform surface minimizes the trauma. Its high strength and good knot security provide long-term wound support. Available in green and white.



Monofilament Nylon

The monofilament Nylon is a polyamide suture with characteristic high tensile strength. The uniform smooth surface permits easy passage through tissue. Available in black, blue and clear.

Braided Silk

Noncapillary Silk has excellent handling and tying characteristics. Modern braiding technique provides a uniform smooth surface and a greater tensile strength. Available in black and white.



Polypropylene

Inert, smooth, and easy to handle and knot securely, Polypropylene is our most versatile monofilament suture. In addition, a unique extruding technique ensures a uniformly round cross section and a strand that passes easily through tissue with better knot security with less throws.

LOOK™



DermaGlide™ Needles

Sharpoint	Ethicon	USS	
3/8 CIRCLE			
DGL11	P-1	P-10	11mm
DGL13	P-3/PC-1		13mm
DGL19	PS-2/PC-5	P-12	19mm
DGL24	PS-1	P-14	24mm
1/2 CIRCLE			
HGL9	P-2	P-21	9mm
HGL16	PS-4/PC-12	P-24	16mm

UltraGlide™ Needles

Sharpoint	Ethicon	USS	
BICURVE			
BGL5	CSB-6		4.88mm
3/8 CIRCLE			
DGL6	CS140-6	SE-140-6	6.15mm
DGL7		SE-140-6	6.60mm
1/2 CIRCLE			
HGL5	CS160-6	SE-160-6	5.51mm
HGL7	CS175-6		6.99mm

Side Cutting Lancet Needles

Sharpoint	Ethicon	USS	Alcon	
Bicurve				
BSL5	TG6-C		CU8, AU-8	5.51mm
1/8 CIRCLE				
SSL5				5.51mm
SSL15				14.99mm
1/4 CIRCLE				
VSL7	TG100-8	SE100-8	C6	6.6mm
DO5	RD-1	SS-24	R-1	8mm
VSP8	S-14, S-24	SS-14	T-1	8mm
VCL8	S-14	SS-14	R1	8.51mm
3/8 CIRCLE				
DSL6	TG140-6	SE140-6	CU1, AU1	6.15mm
DSL7	TG140-8	SE140-8	C-3	6.6mm
1/2 CIRCLE				
HCL5				5mm
HSL5	TG160-6	SE160-6	CU5, AU5	5.51mm
HSL7			C-4	7mm























Precision Reverse Cutting Needles

Sharpoint	LOOK	Ethicon	USS	
3/8 CIRCLE				
DSM7		G-6		7mm
DSM8		P-6	P-16	8mm
DSM11	C1	P-1	P-10	11mm
DSM13	C3	P-3		13mm
DSM16	PC34	PS-3	P-11	16mm
DSM18	PC31	PS-2	P-12	18mm
DSM24	PC33	PS-1	P-14	24mm
1/2 CIRCLE				
	C2	P-2		9mm
	PC30	PS-4		16mm









Reverse Cutting Needles

Sharpoint	LOOK	Ethicon	USS	
3/8 CIRCLE				
	C16	C-2	C-1	11mm
DS12/DS13	C17	C-2		12mm
DS14				14mm
DS16	C22	FS-3	C-12	16mm
DS18/Fine	C6	FS-2	C-13	18mm
DS24	C7	FS-1	C-14	24mm
C8/DS26	C8	FS	C-15	26mm
DS30	C10	FSL	C-16	30mm
DS36				36mm
DS40		FSLX	C-17	40mm
DS90		LR	GS-18	90mm
1/2 CIRCLE				
	C26	M-1		15mm
HS16				16mm
	C19	J-1		18mm
	C20	J-1		20mm
HS24	C9/C31	X-1	C-23	24mm
	C21			26mm
	C12	CP-2	GS-10	27mm
	C13	CP-1	GS-11	37mm
	C14	CP	GS-12	40mm
SKI				
	HC1			22mm





Taper Point

Sharpoint	LOOK	Ethicon	USS
1/4 CIRCLE			
VR4	■	■	4mm 
VR5	■	■	5mm 
3/8 CIRCLE			
DR4	■	BV75-3	4mm 
DR5	■	BV130-4	5mm 
DR6	■	BV130-5	6mm 
IM130-5	■	BV130-5	6mm 
IM175-6	■	BV175-6	8mm 
■	T47	BV-1	CV-1,CVF-1 10mm 
■	T50	BV	CV, CVF 11mm 
DR12/DR13	T12	C-1	CV-11,CVF-11 12mm 
■	T13	BB	CV-15 18mm 
1/2 CIRCLE			
■	T37	RB-3	CV-20 10mm 
HR13	T22	RB-2	CV-22,CVF-22 13mm 
HR17	T28	RB-1	CV-23,CVF-23 18mm 
HR22	T4/T14	SH-1	CV25 22mm 
HR26	T	SH	V-20,VF-20 26mm 
■	T5	CT-2	■ 26.5mm 
HR30	■	■	■ 26.5mm 
HR36	T9	MH	V-26 30mm 
T8	T8	CT-1	GS-21 36mm 
HR40	T10	CT	GS-24 36.6mm 
HRX40	■	■	■ 40mm 
			■ 40mm 

Taper Cutting Needles

Sharpoint	LOOK	Ethicon	USS
3/8 CIRCLE			
■	DE4	CC	10mm 
■	DE3	CC-1	13mm 
DRT14	■	■	14mm 
■	DE12	V-4	KV-15 16mm 
1/2 CIRCLE			
Y5	Y5	V-5	KV-5 16mm 
HRT17	D14	V-5	KV-5 17mm 
HRT26	D13	V-7	KV-7 25mm 
HRT36/HRT38	■	V-34	■ 36mm 







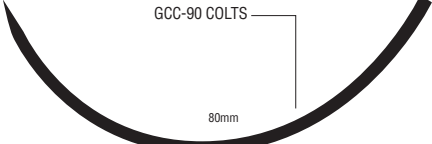

Precision Conventional Cutting Needles

Sharpoint	LOOK	Ethicon	USS
3/8 CIRCLE			
■	CP1	PC-1	PC13 11mm 
DSCM13	■	PC-1	PC13 13mm 
DSCM16	■	PC-3	PC11 16mm 
DSCM18	CP31	PC-5	PC12 18mm 



Conventional Cutting Needles

Sharpoint	USS
3/8 CIRCLE	
DSC80	GCC-90 COLTS 80mm 

M.E.T.™ Point Needles

Sharpoint	Ethicon
BICURVE	
BRM5	■ 5mm 
1/4 CIRCLE	
VRM4	V75-3 4mm 
VRM5	■ 5mm 
VRM6	■ 6mm 
3/8 CIRCLE	
DRM4	■ 4mm 
DRM5	■ 5mm 
DRM6	■ 6mm 
1/2 CIRCLE	
HRM4	■ 4mm 

Vas Cutting Needles

Sharpoint	
1/4 CIRCLE	
VVL4	4mm 
1/2 CIRCLE	
HSV6	6mm 

Straight Taper Point/Cutting Needles /

Sharpoint	LOOK	Ethicon	USS
■	S	■	■
GS60	SC2	KS	SC-2

STERILIZED
POLYPROPYLENE
TAPER CUTTING
POLYVIIOLENE DERMA
POINT ULTRAGLIDE VAS
NYLON POLYSYN FA
BONEWAX TAPER POINT M.E.T. POINT
POLYSYN/POLYGLYCOLIC ACID
CUTTING LANCET DERMAGLIDE BONEWAX
PLAIN GUT ULTRAGLIDE CHROMIC GUT POLYSYN
CENTER POINT SPATULA SIDE CUTTING LANCET DERMAGLIDE
STERITAC SMALLSTITCH PLAIN GUT ULTRAGLIDE CHROMIC
PCL REVERSE CUTTING CENTER POINT SPATULA SIDE CUTTING
STRAIGHT CUTTING STERITAC SILK SMALLSTITCH PLAIN GUT UL
DERMAGLIDE POLYPROPYLENE PCL REVERSE CUTTING CENTER POINT
VAS CUTTING TAPER CUTTING STRAIGHT CUTTING STERITAC SMALLSTITCH
POLYSYN FA POLYVIIOLENE DERMAGLIDE POLYPROPYLENE PCL REVERSE CU
POINT M.E.T. POINT ULTRAGLIDE VAS CUTTING TAPER CUTTING STRAIGHT CUTTING
POLYSYN/POLYGLYCOLIC ACID NYLON POLYSYN FA POLYVIIOLENE DERMAGLIDE POL
LANCET DERMAGLIDE BONEWAX TAPER POINT M.E.T. POINT ULTRAGLIDE VAS CUTTING TAPER
ULTRAGLIDE CHROMIC GUT POLYSYN/POLYGLYCOLIC ACID NYLON POLYSYN FA POLYVIIOLENE
POINT SPATULA SIDE CUTTING LANCET DERMAGLIDE BONEWAX TAPER POINT M.E.T. POINT ULTRAGLID
SILK SMALLSTITCH PLAIN GUT ULTRAGLIDE CHROMIC GUT POLYSYN/POLYGLYCOLIC ACID NYLON POL
PCL REVERSE CUTTING CENTER POINT SPATULA SIDE CUTTING LANCET DERMAGLIDE BONEWAX TAPER POINT M.E.
STRAIGHT CUTTING STERITAC SMALLSTITCH PLAIN GUT ULTRAGLIDE CHROMIC GUT POLYSYN/POLYGLYCOLIC
DERMAGLIDE POLYPROPYLENE PCL REVERSE CUTTING CENTER POINT SPATULA SIDE CUTTING LANCET DERMAGLIDE BONE
VAS CUTTING TAPER CUTTING STRAIGHT CUTTING STERITAC SILK SMALLSTITCH PLAIN GUT ULTRAGLIDE CHROMIC GUT PO
POLYSYN FA POLYVIIOLENE DERMAGLIDE POLYPROPYLENE PCL REVERSE CUTTING CENTER POINT SPATULA SIDE CUTTING LAN
POINT M.E.T. POINT ULTRAGLIDE VAS CUTTING TAPER CUTTING STRAIGHT CUTTING STERITAC SMALLSTITCH PLAIN GUT ULTRAGL
POLYSYN/POLYGLYCOLIC ACID NYLON POLYSYN FA POLYVIIOLENE DERMAGLIDE POLYPROPYLENE PCL REVERSE CUTTING CENTER PO
LANCET DERMAGLIDE BONEWAX TAPER POINT M.E.T. POINT ULTRAGLIDE VAS CUTTING TAPER CUTTING STRAIGHT CUTTING STERITAC SILK SMA
ULTRAGLIDE CHROMIC GUT POLYSYN/POLYGLYCOLIC ACID NYLON POLYSYN FA POLYVIIOLENE DERMAGLIDE POLYPROPYLENE PCL REVERSE C
POINT SPATULA SIDE CUTTING LANCET DERMAGLIDE BONEWAX TAPER POINT M.E.T. POINT ULTRAGLIDE VAS CUTTING TAPER CUTTING STRAIGHT CUTTING
SMALLSTITCH PLAIN GUT ULTRAGLIDE CHROMIC GUT POLYSYN/POLYGLYCOLIC ACID NYLON POLYSYN FA POLYVIIOLENE DERMAGLIDE POLYPROPYLE
VERSE CUTTING CENTER POINT SPATULA SIDE CUTTING LANCET DERMAGLIDE BONEWAX TAPER POINT M.E.T. POINT ULTRAGLIDE VAS CUTTING TAPER CUTT
STRAIGHT CUTTING STERITAC SILK SMALLSTITCH PLAIN GUT ULTRAGLIDE CHROMIC GUT POLYSYN/POLYGLYCOLIC ACID NYLON POLYSYN FA POLYV
DERMAGLIDE POLYPROPYLENE PCL REVERSE CUTTING CENTER POINT SPATULA SIDE CUTTING LANCET DERMAGLIDE BONEWAX TAPER POINT M.E.T. PO
VAS CUTTING TAPER CUTTING STRAIGHT CUTTING STERITAC SMALLSTITCH PLAIN GUT ULTRAGLIDE CHROMIC GUT POLYSYN/POLYGLYCOLIC
POLYSYN FA POLYVIIOLENE DERMAGLIDE POLYPROPYLENE PCL REVERSE CUTTING CENTER POINT SPATULA SIDE CUTTING LANCET DERM
POINT M.E.T. POINT ULTRAGLIDE VAS CUTTING TAPER CUTTING STRAIGHT CUTTING STERITAC SILK SMALLSTITCH PLAIN GUT ULTRAGL
POLYSYN/POLYGLYCOLIC ACID NYLON POLYSYN FA POLYVIIOLENE DERMAGLIDE POLYPROPYLENE PCL REVERSE CUTTING CENT
LANCET DERMAGLIDE BONEWAX TAPER POINT M.E.T. POINT ULTRAGLIDE VAS CUTTING TAPER CUTTING STRAIGHT CUTTING ST
ULTRAGLIDE CHROMIC GUT POLYSYN/POLYGLYCOLIC ACID NYLON POLYSYN FA POLYVIIOLENE DERMAGLIDE POLYPP
POINT SPATULA SIDE CUTTING LANCET DERMAGLIDE BONEWAX TAPER POINT M.E.T. POINT ULTRAGLIDE VAS CUTTING
SILK SMALLSTITCH PLAIN GUT ULTRAGLIDE CHROMIC GUT POLYSYN/POLYGLYCOLIC ACID NYLON POLYSYN
PCL REVERSE CUTTING CENTER POINT SPATULA SIDE CUTTING LANCET DERMAGLIDE BONEWAX TAPER POINT
STRAIGHT CUTTING STERITAC SMALLSTITCH PLAIN GUT ULTRAGLIDE CHROMIC GUT POLYSYN/POI
DERMAGLIDE POLYPROPYLENE PCL REVERSE CUTTING CENTER POINT SPATULA SIDE CUTTING LAN
VAS CUTTING TAPER CUTTING STRAIGHT CUTTING STERITAC SILK SMALLSTITCH PLAIN GUT U
POLYSYN FA POLYVIIOLENE DERMAGLIDE POLYPROPYLENE PCL REVERSE CUTTING CENT
POINT M.E.T. POINT ULTRAGLIDE VAS CUTTING TAPER CUTTING STRAIGHT CUTTING ST
POLYSYN/POLYGLYCOLIC ACID NYLON POLYSYN FA POLYVIIOLENE DERMAGLID
LANCET DERMAGLIDE BONEWAX TAPER POINT M.E.T. POINT ULTRAGLIDE VAS
ULTRAGLIDE CHROMIC GUT POLYSYN/POLYGLYCOLIC ACID NYLON POL
POINT SPATULA SIDE CUTTING LANCET DERMAGLIDE BONEWAX TAP
SMALLSTITCH PLAIN GUT ULTRAGLIDE CHROMIC GUT POLYS
VERSE CUTTING CENTER POINT SPATULA SIDE CUTTING
STRAIGHT CUTTING STERITAC SILK SMALLSTITCH PL
DERMAGLIDE POLYPROPYLENE PCL REVERSE CUTT
VAS CUTTING TAPER CUTTING STRAIGHT CUTT
POLYSYN FA POLYVIIOLENE DERMAGLID
POINT M.E.T. POINT ULTRAGLIDE VAS
POLYSYN/POLYGLYCOLIC ACID
LANCET DERMAGLIDE BONEW
ULTRAGLIDE CHROMIC
POINT SPATULA SIDE
SILK SMALLSTITCH
PCL REVERSE
STRAIGHT



ABSORBABLE



ABSORBABLE











...AGL
...AS CUTTI
...ON POLYSYN
...X TAPER POINT M.
...POLYSYN/POLYGLYCO
...CUTTING LANCET DERMAGL
...LAIN GUT ULTRAGLIDE CHROM
...CUTTING CENTER POINT SPATULA S
...GHT CUTTING STERITAC SILK SMALLSTIT
...AGLIDE POLYPROPYLENE PCL REVERSE CUTTI
...LIDE VAS CUTTING TAPER CUTTING STRAIGHT CUTTI
...OLYSYN FA POLYVIOLENE DERMAGLIDE POLYPROPYLE
...POINT M.E.T. POINT ULTRAGLIDE VAS CUTTING TAPER CUTTI
...OLYSYN/POLYGLYCOLIC ACID NYLON POLYSYN FA POLYVIOLE
...LANCET DERMAGLIDE BONEWAX TAPER POINT M.E.T. POINT ULTRAGL
...GUT ULTRAGLIDE CHROMIC GUT POLYSYN/POLYGLYCOLIC ACID NYL
...G CENTER POINT SPATULA SIDE CUTTING LANCET DERMAGLIDE BONEWAX TAI
...GHT CUTTING STERITAC SILK SMALLSTITCH PLAIN GUT ULTRAGLIDE CHROMIC C
...MAGLIDE POLYPROPYLENE PCL REVERSE CUTTING CENTER POINT SPATULA SIDE CUTTI
...GLIDE VAS CUTTING TAPER CUTTING STRAIGHT CUTTING STERITAC SMALLSTITCH PLAIN C
...LON POLYSYN FA POLYVIOLENE DERMAGLIDE POLYPROPYLENE PCL REVERSE CUTTING CEN
...AX TAPER POINT M.E.T. POINT ULTRAGLIDE VAS CUTTING TAPER CUTTING STRAIGHT CUTTING STERIT
...GUT POLYSYN/POLYGLYCOLIC ACID NYLON POLYSYN FA POLYVIOLENE DERMAGLIDE POLYPROPYLE
...CUTTING LANCET DERMAGLIDE BONEWAX TAPER POINT M.E.T. POINT ULTRAGLIDE VAS CUTTING TAPER CUTTI
...TCH PLAIN GUT ULTRAGLIDE CHROMIC GUT POLYSYN/POLYGLYCOLIC ACID NYLON POLYSYN FA POLYVIOLE
...SE CUTTING CENTER POINT SPATULA SIDE CUTTING LANCET DERMAGLIDE BONEWAX TAPER POINT M.E.T. POINT ULTRAGL
...GHT CUTTING STERITAC SILK SMALLSTITCH PLAIN GUT ULTRAGLIDE CHROMIC GUT POLYSYN/POLYGLYCOLIC ACID NYL
...MAGLIDE POLYPROPYLENE PCL REVERSE CUTTING CENTER POINT SPATULA SIDE CUTTING LANCET DERMAGLIDE BONEWAX TAI
...ENT ULTRAGLIDE VAS CUTTING TAPER CUTTING STRAIGHT CUTTING STERITAC SMALLSTITCH PLAIN GUT ULTRAGLIDE CHROMIC C
...C ACID NYLON POLYSYN FA POLYVIOLENE DERMAGLIDE POLYPROPYLENE PCL REVERSE CUTTING CENTER POINT SPATULA SIDE CUTTI
...E BONEWAX TAPER POINT M.E.T. POINT ULTRAGLIDE VAS CUTTING TAPER CUTTING STRAIGHT CUTTING STERITAC SILK SMALLSTITCH PLAIN C
...MOMIC GUT POLYSYN/POLYGLYCOLIC ACID NYLON POLYSYN FA POLYVIOLENE DERMAGLIDE POLYPROPYLENE PCL REVERSE CUTTING CEN
...ULA SIDE CUTTING LANCET DERMAGLIDE BONEWAX TAPER POINT M.E.T. POINT ULTRAGLIDE VAS CUTTING TAPER CUTTING STRAIGHT CUTTING STERIT
...LSTITCH PLAIN GUT ULTRAGLIDE CHROMIC GUT POLYSYN/POLYGLYCOLIC ACID NYLON POLYSYN FA POLYVIOLENE DERMAGLIDE POLYPROPYLENE PCL REVERSE CUTTING CEN
...RSE CUTTING CENTER POINT SPATULA SIDE CUTTING LANCET DERMAGLIDE BONEWAX TAPER POINT M.E.T. POINT ULTRAGLIDE VAS CUTTING TAPER CUTTI
...HT CUTTING STERITAC SILK SMALLSTITCH PLAIN GUT ULTRAGLIDE CHROMIC GUT POLYSYN/POLYGLYCOLIC ACID NYLON POLYSYN FA POLYVIOLE
...POLYPROPYLENE PCL REVERSE CUTTING CENTER POINT SPATULA SIDE CUTTING LANCET DERMAGLIDE BONEWAX TAPER POINT M.E.T. POINT ULTRAGL
...TAPER CUTTING STRAIGHT CUTTING STERITAC SMALLSTITCH PLAIN GUT ULTRAGLIDE CHROMIC GUT POLYSYN/POLYGLYCOLIC ACID NYL
...FINE DERMAGLIDE POLYPROPYLENE PCL REVERSE CUTTING CENTER POINT SPATULA SIDE CUTTING LANCET DERMAGLIDE BONEWAX TAI
...ULTRAGLIDE VAS CUTTING TAPER CUTTING STRAIGHT CUTTING STERITAC SILK SMALLSTITCH PLAIN GUT ULTRAGLIDE CHROMIC C
...NYLON POLYSYN FA POLYVIOLENE DERMAGLIDE POLYPROPYLENE PCL REVERSE CUTTING CENTER POINT SPATULA SIDE CUTTI
...TAPER POINT M.E.T. POINT ULTRAGLIDE VAS CUTTING TAPER CUTTING STRAIGHT CUTTING STERITAC SMALLSTITCH PLAIN C
...POLYGLYCOLIC ACID NYLON POLYSYN FA POLYVIOLENE DERMAGLIDE POLYPROPYLENE PCL REVERSE CUTTING CEN
...MAGLIDE BONEWAX TAPER POINT M.E.T. POINT ULTRAGLIDE VAS CUTTING TAPER CUTTING STRAIGHT CUTTING STERIT
...MOMIC GUT POLYSYN/POLYGLYCOLIC ACID NYLON POLYSYN FA POLYVIOLENE DERMAGLIDE POLYPROPYLE
...CUTTING LANCET DERMAGLIDE BONEWAX TAPER POINT M.E.T. POINT ULTRAGLIDE VAS CUTTING TAPER CUTTI
...GUT ULTRAGLIDE CHROMIC GUT POLYSYN/POLYGLYCOLIC ACID NYLON POLYSYN FA POLYVIOLE
...POINT SPATULA SIDE CUTTING LANCET DERMAGLIDE BONEWAX TAPER POINT M.E.T. POINT ULTRAGL
...SMALLSTITCH PLAIN GUT ULTRAGLIDE CHROMIC GUT POLYSYN/POLYGLYCOLIC ACID NYL
...SE CUTTING CENTER POINT SPATULA SIDE CUTTING LANCET DERMAGLIDE BONEWAX TAI
...STRAIGHT CUTTING STERITAC SMALLSTITCH PLAIN GUT ULTRAGLIDE CHROMIC C
...POLYPROPYLENE PCL REVERSE CUTTING CENTER POINT SPATULA SIDE CUTTI
...TAPER CUTTING STRAIGHT CUTTING STERITAC SILK SMALLSTITCH PLAIN C
...VIOLENE DERMAGLIDE POLYPROPYLENE PCL REVERSE CUTTING CEN
...MAGLIDE VAS CUTTING TAPER CUTTING STRAIGHT CUTTING STERIT
...POLYSYN FA POLYVIOLENE DERMAGLIDE POLYPROPYLENE PCL REVERSE CUTTING CEN
...NT M.E.T. POINT ULTRAGLIDE VAS CUTTING TAPER CUTTI
...YGLYCOLIC ACID NYLON POLYSYN FA POLYVIOLE
...BONEWAX TAPER POINT M.E.T. POINT ULTRAGL
...GUT POLYSYN/POLYGLYCOLIC ACID NYL
...G LANCET DERMAGLIDE BONEWAX TAI
...IN GUT ULTRAGLIDE CHROMIC C
...TTER POINT SPATULA SIDE CUTTI
...C SMALLSTITCH PLAIN C
...RSE CUTTING CEN
...CUTTING STERIT
...POLYPROPYLE
...P CUTTI
...OLE

PLAIN GUT





DermaGlide™

NEEDLE	MATERIAL	LENGTH	SIZE							
			6-0	5-0	4-0	3-0	2-0	0	1	
 DGL11 11.00mm 3/8 Circle (P-1)	Plain Gut	18"/45cm	BD-660N 							

Precision Reverse Cutting

NEEDLE	MATERIAL	LENGTH	SIZE							
			6-0	5-0	4-0	3-0	2-0	0	1	
 DSM11 11.00mm 3/8 Circle (P-1)	Plain Gut	12"/30cm	BA-2698N 							
		18"/45cm	BA-2415N  774G							
 DSM11 11.00mm 3/8 Circle (G-1)	Plain Gut	18"/45cm	BA-770N  770G							
 DSM13 C3 13.00mm 3/8 Circle (P-3)	Plain Gut	18"/45cm		 596B 686G	 1241B 1644G					







Precision Conventional Cutting

NEEDLE	MATERIAL	LENGTH	SIZE							
			6-0	5-0	4-0	3-0	2-0	0	1	
 CP1 11.00mm 3/8 Circle (PC-1)	Plain Gut	18"/45cm	 1415B							
 DSCM13 13.00mm 3/8 Circle (PC-1)	Plain Gut	18"/45cm	BA-2711N 							

Product numbers are color coded respectively as Sharpoint™ (blue), LOOK™ (purple) and Ethicon (black).
B or **N** denotes a box of 12; **D** denotes a box of 36.



Reverse Cutting ▾

PLAIN GUT









NEEDLE	MATERIAL	LENGTH	SIZE						
			6-0	5-0	4-0	3-0	2-0	0	1
C17 12.00mm 3/8 Circle  (C-2)	Plain Gut	10"/25cm		▪ 521B ▪	▪ 531B ▪				
		18"/45cm		▪ 535B ▪	▪ 536B ▪				
DS18 C6 18.00mm 3/8 Circle  (FS-2)	Plain Gut	18"/45cm		▪ 500B ▪	▪ BC-2463N 591B ▪	▪ 592B ▪			
		27"/70cm		▪ 550B H820G	▪ 551B H821G	▪ 554B H822G			
		30"/75cm			▪ BC-1102D ▪	▪ BC-1103D ▪			
DS24 C7 24.00mm 3/8 Circle  (FS-1)	Plain Gut	27"/70cm				▪ 553B H810H	▪ 555B H823H		
		30"/75cm				▪ BC-1106D ▪			
C26 15.00mm 1/2 Circle  (M-1)	Plain Gut	18"/45cm			▪ 537B ▪				
HS24 C31 24.00mm 1/2 Circle  (X-1)	Plain Gut	18"/45cm			▪ 599B ▪	▪ 594B 612G			
C21 26.00mm 1/2 Circle 	Plain Gut	18"/45cm				▪ 593B ▪			

CHROMIC GUT

DermaGlide™























NEEDLE	MATERIAL	LENGTH	SIZE							
			6-0	5-0	4-0	3-0	2-0	0	1	
DGL13 13.00mm 3/8 Circle  (P-3, PC-1)	Chromic Gut	18"/45cm		CD-687DA  						

Precision Reverse Cutting

NEEDLE	MATERIAL	LENGTH	SIZE						
			6-0	5-0	4-0	3-0	2-0	0	1
C1 11.00mm 3/8 Circle  (P-1)	Chromic Gut	12"/30cm	 1242B 						
C3 13.00mm 3/8 Circle  (P-3)	Chromic Gut	18"/45cm		 1248B 687G	 595B 1654G				
DSM18 PC31 18.00mm 3/8 Circle  (PS-2)	Chromic Gut	18"/45cm			 1253B 1637G				
		30"/75cm				CA-2417N  1638G			



















Product numbers are color coded respectively as Sharpoint™ (blue), LOOK™ (purple) and Ethicon (black).
B or **N** denotes a box of 12; **D** denotes a box of 36.

Reverse Cutting ▾

NEEDLE	MATERIAL	LENGTH	SIZE						
			6-0	5-0	4-0	3-0	2-0	0	1
C16  11.00mm 3/8 Circle (C-2)	Chromic Gut	18"/45cm		 543B					
C17  12.00mm 3/8 Circle (C-3)	Chromic Gut	18"/45cm		 563B	 546B				
DS18 C6  18.00mm 3/8 Circle (FS-2)	Chromic Gut	18"/45cm			 558B	 525B			
		27"/70cm		 557B 634G	 559B 635G	 560B 636G			
		30"/75cm		 CC-0935N		 CC-0937D			
C7  24.00mm 3/8 Circle (FS-1)	Chromic Gut	27"/70cm					 561B 637G		
C8  26.00mm 3/8 Circle (FS)	Chromic Gut	27"/70cm					 562B 638G		
C26  15.00mm 1/2 Circle (M-1)	Chromic Gut	14"/35cm		 598B	 544B				
C20  20.00mm 1/2 Circle	Chromic Gut	30"/75cm			 547B				

CHROMIC GUT

Taper Point

NEEDLE	MATERIAL	LENGTH	SIZE						
			6-0	5-0	4-0	3-0	2-0	0	1
T28 17.00mm 1/2 Circle  (RB-1)	Chromic Gut	14"/35cm		 590B 					
		27"/70cm				CC-0204N  			
HR22 T4 22.00mm 1/2 Circle  (SH-1)	Chromic Gut	14"/35cm			 589B 				
		30"/75cm				CC-0242N  G182H			
HR26 26.00mm 1/2 Circle  (SH)	Chromic Gut	30"/75cm			CC-0302N*  G121H	CC-0153N  G122H	CC-0272N  G123H		
HR30 30.00mm 1/2 Circle  	Chromic Gut	30"/75cm					CC-0244N  		
HR36 36.00mm 1/2 Circle  (MH)	Chromic Gut	30"/75cm					CC-0245N  		

Product numbers are color coded respectively as Sharpoint (blue), LOOK (purple) and Ethicon (black).
B or **N** denotes a box of 12; **D** denotes a box of 36.









Chromic Gut Strand / Sterile

MATERIAL	LENGTH	SIZE						
		4-0	3-0	2-0	0	1	2	3
Chromic Gut Suture Strand	54"/140cm							CG-2758N  S117H



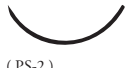









Product numbers are color coded respectively as Sharpoint™ (blue), LOOK™ (purple) and Ethicon (black).
B or **N** denotes a box of 12; **D** denotes a box of 36.

*Made to order. 25 box minimum.

Precision Reverse Cutting ▾

NEEDLE	MATERIAL	LENGTH	SIZE						
			6-0	5-0	4-0	3-0	2-0	0	1
DSM11  11.00mm 3/8 Circle (P-1)	Undyed Braided	18"/45cm		MA-490N  VR490					
DSM13  13.00mm 3/8 Circle (P-3)		18"/45cm		MA-494N  VR494					
DSM18  18.00mm 3/8 Circle (PS-2)		18"/45cm		MA-496N  VR496	MA-497N  				
		27"/70cm		MA-426N  VR426					





Reverse Cutting ▾

NEEDLE	MATERIAL	LENGTH	SIZE						
			6-0	5-0	4-0	3-0	2-0	0	1
DS18  18.00mm 3/8 Circle (FS-2)	Undyed Braided	18"/45cm			MC-492N  	MC-493N  			
		27"/70cm		MC-422N  					
DS24  24.00mm 3/8 Circle (FS-1)	Undyed Braided	27"/70cm				MC-442N  			
HS24  24.00mm 1/2 Circle (X-1)	Undyed Braided	18"/45cm				MC-456N  			

Product numbers are color coded respectively as Sharpoint™ (blue), LOOK™ (purple) and Ethicon (black).
B or **N** denotes a box of 12; **D** denotes a box of 36.



Taper Point 







NEEDLE	MATERIAL	LENGTH	SIZE						
			6-0	5-0	4-0	3-0	2-0	0	1
DGL11  11.00mm 3/8 Circle (P-1)	Undyed Braided	18"/45cm		MD-834N 					
HR17  17.00mm 1/2 Circle (RB-1)	Undyed Braided	27"/70cm			MC-214N  VR214				

POLYSYN FA™ / POLYGLYCOLIC ACID



POLYSYN™/POLYGLYCOLIC ACID

POLYSYN™/POLYGLYCOLIC ACID

DermaGlide™

NEEDLE	MATERIAL	LENGTH	SIZE						
			9-0	8-0	7-0	6-0	5-0	4-0	3-0
DGL11  11.00mm 3/8 Circle (P-1)	Undyed Braided	8"/20cm				GD-489S ■ ■			
DGL13  13.00mm 3/8 Circle (P-3, PC-1)		8"/20cm				GD-492S ■ ■	GD-493S ■ ■	GD-494S ■ ■	
DGL19  19.00mm 3/8 Circle (PS-2, PC-5)	Undyed Braided	8"/20cm					GD-495S ■ ■	GD-496S ■ ■	
		18"/45cm				GD-492N ■ J492G J833G	GD-493N ■ J493G J834G	GD-494N ■ J494G J835G	
HGL6  5.50mm 1/2 Circle (CS-160-8)	Undyed Braided	12"/30cm	*GA-449N ■ V449G						
		18"/45cm					GD-503N ■ J503G	GD-504N ■ ■	
HGL9  9.00mm 1/2 Circle (P-2)	Undyed Braided	18"/45cm							
HGL16  16.00mm 1/2 Circle (PS-4)	Undyed Braided	18"/45cm					GD-506N ■ J506G	GD-507N ■ J507G	









UltraGlide™

NEEDLE	DESCRIPTION	MATERIAL	LENGTH	SIZE			
				10-0	9-0	8-0	7-0
BGL5  (CSB-6)	Bicurve Radius 1.52/2.79mm Length 4.88mm Chord 3.71mm Curvature 90/50 Wire .15mm	Violet Monofilament	4"/10cm	GA-966N ■ V966G			
VGL7  (CS90-6)	1/4 Circle Length 7.00mm	Violet Monofilament	4"/10cm	GA-980N ■ V980			











Product numbers are color coded respectively as SharpPoint™ (blue), LOOK™ (purple) and Ethicon (black).
B or **N** denotes a box of 12; **D** denotes a box of 36.
S denotes SmallStitch™.

* Available in 2008.

UltraGlide™ 





NEEDLE	DESCRIPTION	MATERIAL	LENGTH	SIZE			
				10-0	9-0	8-0	7-0
DGL6  (CS140-6)	3/8 Circle Length 6.15mm Curvature 135 Radius 2.54mm Chord 4.82mm Wire .15mm	Violet Monofilament	4"/10cm	GA-960N  V960G			
DGL7  (TG140)	3/8 Circle Length 6.60mm Curvature 131 Radius 2.79mm Chord 5.26mm Wire .20mm	Violet Monofilament	12"/30cm	GA-460N  ■			
DGL7  (TG140)	3/8 Circle Length 6.60mm Curvature 131 Radius 2.79mm Chord 5.26mm Wire .20mm	Violet Monofilament	12"/30cm	GA-462N  ■			
HGL5  (CS160-6)	1/2 Circle Length 5.51mm Curvature 150 Radius 2.03mm Chord 4.06mm Wire .15mm	Violet Monofilament	12"/30cm	GA-448N  ■ V448G			

Side Cutting Lancet 



NEEDLE	DESCRIPTION	MATERIAL	LENGTH	SIZE				
				9-0	8-0	7-0	6-0	5-0
VSL7  (TG100-8)	1/4 Circle Length 6.60mm Curvature 94 Radius 3.94mm Chord 5.89mm Wire .20mm	Violet Braided	18"/45cm				GA-544N  J544G	
VCL8  (TG100-8)	1/4 Circle Length 8.51mm Curvature 112 Radius 4.36mm Chord 7.24mm Wire .33mm	Undyed Braided	18"/45cm				GA-670N  J670G	GA-671N  J671G
	1/4 Circle Length 8.51mm Curvature 109 Radius 4.32mm Chord 7.28mm Wire .34mm	Violet Braided	8"/20cm	GA-590N  J590G				
VSP8  (S-29)	1/4 Circle Length 7.62mm Curvature 110 Radius 3.97mm Chord 6.5mm Wire .20mm	Violet Braided	12"/30cm				GA-570N  J570G	
	18"/45cm					GA-556N  J556G		
			18"/45cm				GA-555N  J555G	

POLYSYN™/POLYGLYCOLIC ACID

Side Cutting Lancet

















NEEDLE	DESCRIPTION	MATERIAL	LENGTH	SIZE					
				9-0	8-0	7-0	6-0	5-0	
VSP8  (S-24)	1/4 Circle Length 8.13mm Curvature 90	Radius 5.16mm Chord 7.29mm Wire .3mm	Violet Braided	12"/30cm				GA-552N ■ J552G	GA-553N ■ J553G
DSL6  (TG140-6)	3/8 Circle Length 6.20mm Curvature 140	Radius 2.38mm Chord 4.77mm Wire .150mm	Violet Braided	12"/30cm		GA-974N ■ J974G			
DSL7  (TG140-8)	3/8 Circle Length 6.60mm Curvature 131	Radius 2.79mm Chord 5.25mm Wire .20mm	Violet Braided	8"/20cm		GA-547N ■ J547G			
				12"/30cm		GA-548N ■ J548G	GA-566N ■ J566G		
				18"/45cm			GA-546N ■ J546G		
HSL6  (TG160)	1/2 Circle Length 5.54mm Curvature 160	Radius 19.84mm Chord 3.9mm Wire .2mm	Violet Braided	8"/20cm		GA-574N ■ J574G			
				12"/30cm			GA-575N ■ J575G		

Precision Reverse Cutting





NEEDLE	MATERIAL	LENGTH	SIZE						
			6-0	5-0	4-0	3-0	2-0	0	1
C3  (P-3)	Undyed Braided	18"/45cm	■ 492B J492G	■ 493B J493G	■ 494B J494G				
DSM11  (PS-1)	Undyed Braided	18"/45cm		GA-490N ■					
DSM13  (PS-3)	Violet Braided	18"/45cm			GA-463N ■				

Product numbers are color coded respectively as SharpPoint™ (blue), LOOK™ (purple) and Ethicon (black).
B or **N** denotes a box of 12; **D** denotes a box of 36.

Precision Reverse Cutting ▾



NEEDLE	MATERIAL	LENGTH	SIZE							
			6-0	5-0	4-0	3-0	2-0	0	1	
DSM16 16.00mm 3/8 Circle  (PS-3)	Undyed Braided	18"/45cm	GA-499N  J499G	GA-500N  J500G		GA-0508N  ■				
DSM18 18.00mm 3/8 Circle  (PS-2)	Undyed Braided	27"/70cm			GA-426N  ■	GA-427N  ■				
PC30 18.00mm 1/2 Circle  (PS-4)	Undyed Braided	18"/45cm		GA-506N  ■	GA-507N  ■					
PC31 19.00mm 3/8 Circle  (PS-2)	Undyed Braided	18"/45cm		 495B J495G	 496B J496G	 497B J497G				
PC33 24.00mm 3/8 Circle  (PS-1)	Undyed Braided	18"/45cm				 683B J683G				

Precision Conventional Cutting ▲







NEEDLE	MATERIAL	LENGTH	SIZE							
			10-0	9-0	8-0	7-0	6-0	5-0	4-0	
DSCM13 13.00mm 3/8 Circle  (PC-1)	Undyed Braided	18"/45cm							GA-834N  J834G	
DSCM16 16.00mm 3/8 Circle  (PC-1)	Undyed Braided	18"/45cm								GA-845N  ■

POLYSYN™/POLYGLYCOLIC ACID













Diamond Point

NEEDLE	MATERIAL	LENGTH	SIZE						
			10-0	9-0	8-0	7-0	6-0	5-0	4-0
DE7  (RD-1)	8.13mm 3/8 Circle Violet Braided	12"/30cm					GA-446N  J446G		

Taper Cutting



NEEDLE	MATERIAL	LENGTH	SIZE						
			10-0	9-0	8-0	7-0	6-0	5-0	4-0
DRTM4  (BV-100-3)	4.00mm 3/8 Circle Violet Monofilament	5"/13cm	GA-7498N  D7498						
DRTM5  (BV-130-4)	5.00mm 3/8 Circle Violet Braided	5"/13cm			GA-405N  J405G				
DRTM6  (BV-130-5)	6.00mm 3/8 Circle Violet Braided	5"/13cm			GA-401N  J401G				

Reverse Cutting





NEEDLE	MATERIAL	LENGTH	SIZE						
			6-0	5-0	4-0	3-0	2-0	0	1
C17  (C-3)	12.00mm 3/8 Circle Undyed Braided	10"/25cm			 386B 				
C6  (FS-2)	19.00mm 3/8 Circle Violet Braided	18"/45cm				GC-393N  			
	Undyed Braided	27"/70cm		 421B J421H	 422B J422H	 423B J423H			
C7  (FS-1)	24.00mm 3/8 Circle Undyed Braided	27"/70cm			 441B J441H	 442B J442H	 443B J443H		

Product numbers are color coded respectively as SharpPoint™ (blue), LOOK™ (purple) and Ethicon (black).
B or **N** denotes a box of 12; **D** denotes a box of 36.

Reverse Cutting ▾



NEEDLE	MATERIAL	LENGTH	SIZE						
			6-0	5-0	4-0	3-0	2-0	0	1
C14 40.00mm 1/2 Circle  (CP)	Violet Braided	27"/70cm							■ 480B J480H
DS18 18.00mm 3/8 Circle  (FS-2)	Violet Braided	18"/45cm		GC-391N ■ ■	GC-392N ■ ■				

Taper Point ⊙

NEEDLE	MATERIAL	LENGTH	SIZE						
			6-0	5-0	4-0	3-0	2-0	0	1
T28 18.00mm 1/2 Circle  (RB-1)	Undyed Braided	27"/70cm			GC-214N ■ ■				
T14 20.00mm 1/2 Circle  (SH-1)	Violet Braided	27"/70cm				■ 311B J311G			
T 26.00mm 1/2 Circle  (SH)	Violet Braided	27"/70cm				■ 316B J316G	■ 317B J317G		
T5 26.50mm 1/2 Circle  (CT-2)	Violet Braided	27"/70cm				■ 332B J332H	■ 333B J333H		
	Undyed Braided	27"/70cm				GC-232N ■ ■	GC-269N ■ ■		
HR26 26.00mm 1/2 Circle  (SH)	Undyed Braided	18"/45cm					GC-417N ■ ■		
		27"/70cm				GC-416N ■ ■			























POLYSYN™/POLYGLYCOLIC ACID

Taper Point









NEEDLE	MATERIAL	LENGTH	SIZE						
			10-0	9-0	8-0	7-0	6-0	5-0	4-0
T8 36.60mm 1/2 Circle  (CT-1)	Undyed Braided	18"/45cm					GC-259N ■ ■		
		27"/70cm					GC-260N ■ ■		
		36"/90cm					GC-945N ■ ■		
	Violet Braided	27"/70cm					■ 339B J339H	■ 340B J340H	■ 341B J341H
T10 40.00mm 1/2 Circle  (CT)	Violet Braided	27"/70cm						■ 352B J352H	■ 353B J353H

Product numbers are color coded respectively as Sharpoint™ (blue), LOOK™ (purple) and Ethicon (black).
B or **N** denotes a box of 12; **D** denotes a box of 36.

DermaGlide™





NEEDLE	MATERIAL	LENGTH	SIZE						
			6-0	5-0	4-0	3-0	2-0	0	1
DGL11  11.00mm 3/8 Circle (P-1)	Undyed Monofilament	18"/45cm	YD-489N  Y489G	YD-490N  Y490G					
DGL13  13.00mm 3/8 Circle (P-3, PC-1)	Undyed Monofilament	18"/45cm	YD-492N  Y492G	YD-493N  Y493G	YD-494N  Y494G				
	Violet Monofilament	18"/45cm		YD-463N  Y463G	YD-464N  Y464G				
DGL19  19.00mm 3/8 Circle (PS-2, PC-5)	Undyed Monofilament	18"/45cm		YD-495N  Y495G	YD-496N  Y496G	YD-497N  Y497G			
	Violet Monofilament	18"/45cm			YD-513N  Y513G				
DGL24  24.00mm 3/8 Circle (PS-1)	Undyed Monofilament	18"/45cm			YD-682N  Y682H	YD-936N  Y936H			
HGL9  9.00mm 1/2 Circle (P-2)	Undyed Monofilament	18"/45cm		YD-503N  	YD-504N  				

Precision Reverse Cutting



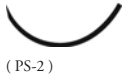





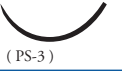

NEEDLE	MATERIAL	LENGTH	SIZE						
			6-0	5-0	4-0	3-0	2-0	0	1
DSM11  11.00mm 3/8 Circle (P-1)	Undyed Monofilament	18"/45cm	YP-489N  Y489G	YP-490N  Y490G					
DSM13  13.00mm 3/8 Circle (P-3)	Undyed Monofilament	18"/45cm	YP-492N  Y492G	YP-493N  Y493G	YP-494N  Y494G				
	Violet Monofilament	18"/45cm		YP-463N  Y463G	YP-464N  Y464G				

Product numbers are color coded respectively as Sharp™ (blue), LOOK™ (purple) and Ethicon (black).
B or **N** denotes a box of 12; **D** denotes a box of 36.





Precision Reverse Cutting ▾

NEEDLE	MATERIAL	LENGTH	SIZE							
			6-0	5-0	4-0	3-0	2-0	0	1	
DSM19 19.00mm 3/8 Circle  (PS-2)	Undyed Monofilament	18"/45cm		YP-495N  Y495G	YP-496N  Y496G	YP-497N  Y497G				
	Violet Monofilament	18"/45cm			YP-513N  Y513G					

















Precision Conventional Cutting Needles ▲

NEEDLE	MATERIAL	LENGTH	SIZE							
			6-0	5-0	4-0	3-0	2-0	0	1	
DSCM16 16.00mm 3/8 Circle  (PS-3)	Undyed Monofilament	18"/45cm		YP-844N  	YP-845N  					
DSCM19 19.00mm 3/8 Circle  (PC-2)	Undyed Monofilament	18"/45cm		YP-822N  	YP-823N  					







Taper Point ●

NEEDLE	MATERIAL	LENGTH	SIZE							
			6-0	5-0	4-0	3-0	2-0	0	1	
HR13 13.00mm 1/2 Circle  (TF)	Undyed Monofilament	18"/45cm	YT-432N  Y432G	YT-433N  Y433G	YT-434N  Y434G					

DermaGlide™ 











NEEDLE	MATERIAL	LENGTH	SIZE							
			6-0	5-0	4-0	3-0	2-0	0	1	
DGL11  11.00mm 3/8 Circle (P-1)	Clear Monofilament	18"/45cm	QD-489N  Z489G	QD-490N  Z490G						
DGL13  13.00mm 3/8 Circle (P-3, PC-1)	Clear Monofilament	18"/45cm	QD-492N  Z833G	QD-493N  Z493G	QD-494N  Z494G					
DGL19  19.00mm 3/8 Circle (PS-2, PC-5)	Clear Monofilament	18"/45cm		QD-495N  Z495G	QD-496N  Z496G Z823G	QD-497N  Z497G Z824G				
DGL24  24.00mm 3/8 Circle (PS-1)	Clear Monofilament	18"/45cm			QD-682N  Z682G	QD-683N  Z683G				
HGL16  16.00mm 1/2 Circle (PS-4, PC-12)	Clear Monofilament	18"/45cm			QD-507N  Z507G					

Reverse Cutting ▽

NEEDLE	MATERIAL	LENGTH	SIZE							
			6-0	5-0	4-0	3-0	2-0	0	1	
C6  18.70mm 3/8 Circle (FS-2)	Violet Monofilament	27"/70cm			NC-397N  Z397H	NC-398N  Z398H				
C13  36.60mm 1/2 Circle (CP-1)	Violet Monofilament	27"/70cm					NC-466N  Z466H		NC-468N  Z468H	

Product numbers are color coded respectively as SharpPoint™ (blue), LOOK™ (purple) and Ethicon (black).
B or **N** denotes a box of 12; **D** denotes a box of 36.

Taper Point

NEEDLE	MATERIAL	LENGTH	SIZE						
			6-0	5-0	4-0	3-0	2-0	0	1
T 26.00mm 1/2 Circle  (SH)	Violet Monofilament	27"/70cm			NC-315N  Z315H	NC-316N  Z316H	NC-317N  Z317H		
T5 26.50mm 1/2 Circle  (CT-2)	Violet Monofilament	27"/70cm				NC-332N  Z332H	NC-333N  Z333H		
T8 36.60mm 1/2 Circle  (CT-1)	Violet Monofilament	27"/70cm					NC-339N  Z339H	NC-340N  Z340H	NC-341N  Z341H

Product numbers are color coded respectively as SharpPoint™ (blue), LOOK™ (purple) and Ethicon (black).
B or **N** denotes a box of 12; **D** denotes a box of 36.

NON-ABSORBABLE

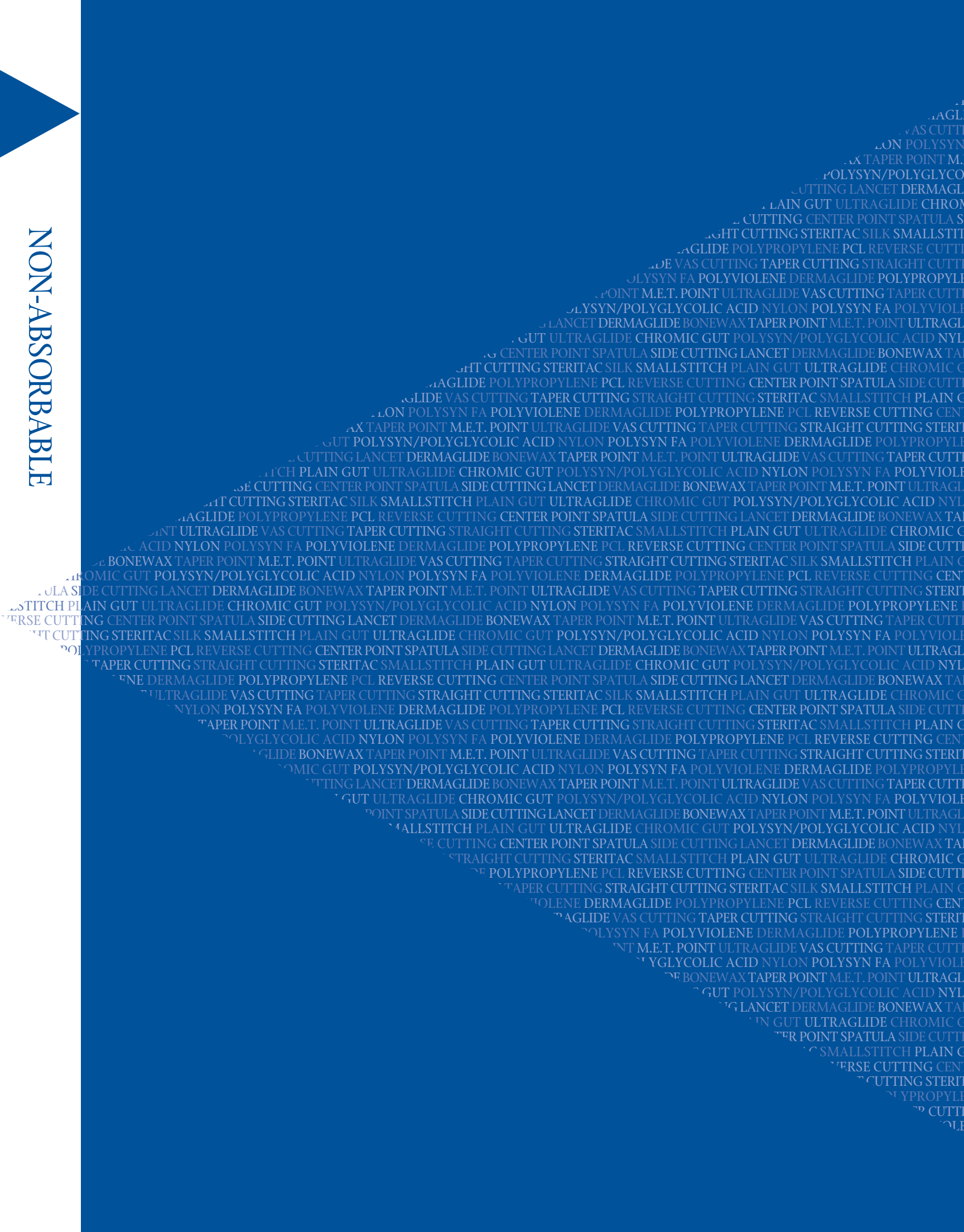



...AGL
...AS CUTTI
...ON POLYSYN
...X TAPER POINT M.
...POLYSYN/POLYGLYCO
...CUTTING LANCET DERMAGL
...LAIN GUT ULTRAGLIDE CHROM
...CUTTING CENTER POINT SPATULA S
...GHT CUTTING STERITAC SILK SMALLSTIT
...AGLIDE POLYPROPYLENE PCL REVERSE CUTTI
...LIDE VAS CUTTING TAPER CUTTING STRAIGHT CUTTI
...OLYSYN FA POLYVIOLENE DERMAGLIDE POLYPROPYLE
...POINT M.E.T. POINT ULTRAGLIDE VAS CUTTING TAPER CUTTI
...OLYSYN/POLYGLYCOLIC ACID NYLON POLYSYN FA POLYVIOLE
...LANCET DERMAGLIDE BONEWAX TAPER POINT M.E.T. POINT ULTRAGL
...GUT ULTRAGLIDE CHROMIC GUT POLYSYN/POLYGLYCOLIC ACID NYL
...G CENTER POINT SPATULA SIDE CUTTING LANCET DERMAGLIDE BONEWAX TAI
...GHT CUTTING STERITAC SILK SMALLSTITCH PLAIN GUT ULTRAGLIDE CHROMIC C
...MAGLIDE POLYPROPYLENE PCL REVERSE CUTTING CENTER POINT SPATULA SIDE CUTTI
...GLIDE VAS CUTTING TAPER CUTTING STRAIGHT CUTTING STERITAC SMALLSTITCH PLAIN C
...LON POLYSYN FA POLYVIOLENE DERMAGLIDE POLYPROPYLENE PCL REVERSE CUTTING CEN
...AX TAPER POINT M.E.T. POINT ULTRAGLIDE VAS CUTTING TAPER CUTTING STRAIGHT CUTTING STERIT
...GUT POLYSYN/POLYGLYCOLIC ACID NYLON POLYSYN FA POLYVIOLENE DERMAGLIDE POLYPROPYLE
...CUTTING LANCET DERMAGLIDE BONEWAX TAPER POINT M.E.T. POINT ULTRAGLIDE VAS CUTTING TAPER CUTTI
...TCH PLAIN GUT ULTRAGLIDE CHROMIC GUT POLYSYN/POLYGLYCOLIC ACID NYLON POLYSYN FA POLYVIOLE
...SE CUTTING CENTER POINT SPATULA SIDE CUTTING LANCET DERMAGLIDE BONEWAX TAPER POINT M.E.T. POINT ULTRAGL
...GHT CUTTING STERITAC SILK SMALLSTITCH PLAIN GUT ULTRAGLIDE CHROMIC GUT POLYSYN/POLYGLYCOLIC ACID NYL
...MAGLIDE POLYPROPYLENE PCL REVERSE CUTTING CENTER POINT SPATULA SIDE CUTTING LANCET DERMAGLIDE BONEWAX TAI
...ENT ULTRAGLIDE VAS CUTTING TAPER CUTTING STRAIGHT CUTTING STERITAC SMALLSTITCH PLAIN GUT ULTRAGLIDE CHROMIC C
...C ACID NYLON POLYSYN FA POLYVIOLENE DERMAGLIDE POLYPROPYLENE PCL REVERSE CUTTING CENTER POINT SPATULA SIDE CUTTI
...E BONEWAX TAPER POINT M.E.T. POINT ULTRAGLIDE VAS CUTTING TAPER CUTTING STRAIGHT CUTTING STERITAC SILK SMALLSTITCH PLAIN C
...MOMIC GUT POLYSYN/POLYGLYCOLIC ACID NYLON POLYSYN FA POLYVIOLENE DERMAGLIDE POLYPROPYLENE PCL REVERSE CUTTING CEN
...ULA SIDE CUTTING LANCET DERMAGLIDE BONEWAX TAPER POINT M.E.T. POINT ULTRAGLIDE VAS CUTTING TAPER CUTTING STRAIGHT CUTTING STERIT
...LSTITCH PLAIN GUT ULTRAGLIDE CHROMIC GUT POLYSYN/POLYGLYCOLIC ACID NYLON POLYSYN FA POLYVIOLENE DERMAGLIDE POLYPROPYLENE P
...VERSE CUTTING CENTER POINT SPATULA SIDE CUTTING LANCET DERMAGLIDE BONEWAX TAPER POINT M.E.T. POINT ULTRAGLIDE VAS CUTTING TAPER CUTTI
...HT CUTTING STERITAC SILK SMALLSTITCH PLAIN GUT ULTRAGLIDE CHROMIC GUT POLYSYN/POLYGLYCOLIC ACID NYLON POLYSYN FA POLYVIOLE
...POLYPROPYLENE PCL REVERSE CUTTING CENTER POINT SPATULA SIDE CUTTING LANCET DERMAGLIDE BONEWAX TAPER POINT M.E.T. POINT ULTRAGL
...TAPER CUTTING STRAIGHT CUTTING STERITAC SMALLSTITCH PLAIN GUT ULTRAGLIDE CHROMIC GUT POLYSYN/POLYGLYCOLIC ACID NYL
...FINE DERMAGLIDE POLYPROPYLENE PCL REVERSE CUTTING CENTER POINT SPATULA SIDE CUTTING LANCET DERMAGLIDE BONEWAX TAI
...ULTRAGLIDE VAS CUTTING TAPER CUTTING STRAIGHT CUTTING STERITAC SILK SMALLSTITCH PLAIN GUT ULTRAGLIDE CHROMIC C
...NYLON POLYSYN FA POLYVIOLENE DERMAGLIDE POLYPROPYLENE PCL REVERSE CUTTING CENTER POINT SPATULA SIDE CUTTI
...TAPER POINT M.E.T. POINT ULTRAGLIDE VAS CUTTING TAPER CUTTING STRAIGHT CUTTING STERITAC SMALLSTITCH PLAIN C
...POLYGLYCOLIC ACID NYLON POLYSYN FA POLYVIOLENE DERMAGLIDE POLYPROPYLENE PCL REVERSE CUTTING CEN
...GLIDE BONEWAX TAPER POINT M.E.T. POINT ULTRAGLIDE VAS CUTTING TAPER CUTTING STRAIGHT CUTTING STERIT
...MOMIC GUT POLYSYN/POLYGLYCOLIC ACID NYLON POLYSYN FA POLYVIOLENE DERMAGLIDE POLYPROPYLE
...CUTTING LANCET DERMAGLIDE BONEWAX TAPER POINT M.E.T. POINT ULTRAGLIDE VAS CUTTING TAPER CUTTI
...GUT ULTRAGLIDE CHROMIC GUT POLYSYN/POLYGLYCOLIC ACID NYLON POLYSYN FA POLYVIOLE
...POINT SPATULA SIDE CUTTING LANCET DERMAGLIDE BONEWAX TAPER POINT M.E.T. POINT ULTRAGL
...SMALLSTITCH PLAIN GUT ULTRAGLIDE CHROMIC GUT POLYSYN/POLYGLYCOLIC ACID NYL
...SE CUTTING CENTER POINT SPATULA SIDE CUTTING LANCET DERMAGLIDE BONEWAX TAI
...STRAIGHT CUTTING STERITAC SMALLSTITCH PLAIN GUT ULTRAGLIDE CHROMIC C
...E POLYPROPYLENE PCL REVERSE CUTTING CENTER POINT SPATULA SIDE CUTTI
...TAPER CUTTING STRAIGHT CUTTING STERITAC SILK SMALLSTITCH PLAIN C
...IOLENE DERMAGLIDE POLYPROPYLENE PCL REVERSE CUTTING CEN
...MAGLIDE VAS CUTTING TAPER CUTTING STRAIGHT CUTTING STERIT
...OLYSYN FA POLYVIOLENE DERMAGLIDE POLYPROPYLENE P
...NT M.E.T. POINT ULTRAGLIDE VAS CUTTING TAPER CUTTI
...YGLYCOLIC ACID NYLON POLYSYN FA POLYVIOLE
...E BONEWAX TAPER POINT M.E.T. POINT ULTRAGL
...GUT POLYSYN/POLYGLYCOLIC ACID NYL
...G LANCET DERMAGLIDE BONEWAX TAI
...IN GUT ULTRAGLIDE CHROMIC C
...TTER POINT SPATULA SIDE CUTTI
...C SMALLSTITCH PLAIN C
...ERSE CUTTING CEN
...CUTTING STERIT
...YPROPYLE
...P CUTTI
...OLE

POLYVIOLENE™/POLYESTER



Precision Reverse Cutting Needles ▾

NEEDLE	MATERIAL	LENGTH	SIZE							
			9-0	8-0	7-0	6-0	5-0	4-0	3-0	
DSM13  13.00mm 3/8 Circle (P-3)	White Braided	18"/45cm							FA-691N ■ ■	

Reverse Cutting ▾



























NEEDLE	MATERIAL	LENGTH	SIZE						
			9-0	8-0	7-0	6-0	5-0	4-0	3-0
G22  16.00mm 3/8 Circle (FS-3)	Green Braided	18"/45cm					■ 1176B ■		
DS18 C6  18.00mm 3/8 Circle (FS-2)	Green Braided	18"/45cm					■ 1180B		
	White Braided	18"/45cm					X683G ■ 1205B ■		

Taper Cutting ▾

NEEDLE	MATERIAL	LENGTH	SIZE						
			6-0	5-0	4-0	3-0	2-0	0	1
Y5  16.00mm 1/2 Circle (V-5)	Green Braided	18"/45cm		■ 797B ■					
HRT17  17.00mm 1/2 Circle (V-5)	Green Braided	12"/30cm Loop			FC-2600N ■	FC-2678N ■			

















Product numbers are color coded respectively as Sharpoint™ (blue), LOOK™ (purple) and Ethicon (black).
B or **N** denotes a box of 12; **D** denotes a box of 36.

NYLON









NEEDLE	MATERIAL	LENGTH	SIZE						
			7-0	6-0	5-0	4-0	3-0	2-0	0
DGL11  11.00mm 3/8 Circle (P-1)	Black Monofilament	8"/20cm		AD-697S  					
		18"/45cm	AD-1696  1696G	AD-697N  697G					
DGL13  13.00mm 3/8 Circle (P-3, PC-1)	Black Monofilament	8"/20cm		AD-1698S  	AD-698S  	AD-699S  			
		18"/45cm		AD-1698  1698G 1856G	AD-698N  698G 1855G	AD-699N  699G 1854G			
	Black Pliable	18"/45cm		AD-1956N  					
DGL19  19.00mm 3/8 Circle (PS-2, PC-5)	Black Monofilament	8"/20cm			AD-1666S  	AD-1667S  			
		18"/45cm			AD-1666  1666G 1895G	AD-1667  1667G 1894G			
HGL16  16.00mm 1/2 Circle (PS-4, PC-12)	Black Monofilament	18"/45cm			AD-1661 	AD-1662 			
					1661G 1845G	1662G			

Product numbers are color coded respectively as Sharpoint™ (blue), LOOK™ (purple) and Ethicon (black).
B or **N** denotes a box of 12; **D** denotes a box of 36.
S denotes SmallStitch™.







UltraGlide™ 

NEEDLE	DESCRIPTION	MATERIAL	LENGTH	SIZE			
				11-0	10-0	9-0	8-0
BGL5  (CSB-6)	Bicurve Length 4.88mm Curvature 90/50 Radius 1.52/2.79mm Chord 3.71mm Wire .15mm	Black Monofilament	12"/30cm		AA-2675N  9007G		
DGL6  (CS140-6)	3/8 Circle Length 6.15mm Curvature 135 Radius 2.54mm Chord 4.82mm Wire .15mm	Black Monofilament	4"/10cm		AA-2673N  		
DGL6  (CS140-6)	3/8 Circle Length 6.15mm Curvature 135 Radius 2.54mm Chord 4.82mm Wire .15mm	Black Monofilament	12"/30cm		AA-2627N  9003G		
HGL5  (CS160-6)	1/2 Circle Length 5.51mm Curvature 160 Radius 2.03mm Chord 4.06mm Wire .15mm	Black Monofilament	4"/10cm		AA-2674N  		
HGL5  (CS160-6)	1/2 Circle Length 5.51mm Curvature 160 Radius 2.03mm Chord 4.06mm Wire .15mm	Black Monofilament	6"/15cm	AA-2713N  9016G	AA-2712N  9001G		
			12"/30cm		AA-2626N  9000G		
HGL7  (CS175-8)	1/2 Circle Length 6.99mm Curvature 175 Radius 2.29mm Chord 4.57mm Wire .15mm	Black Monofilament	12"/30cm		AA-2714N  9032G		

Side Cutting Lancet 

NEEDLE	DESCRIPTION	MATERIAL	LENGTH	SIZE			
				11-0	10-0	9-0	8-0
BSL5  (TG6-C)	Bicurve Length 4.88mm Curvature 90/50 Radius 1.52/2.79mm Chord 3.71mm Wire .15mm	Black Monofilament	6"/15cm		AA-2687N  		
			12"/30cm		AA-2522N  		
BSL5  (TG6-C)	Bicurve Length 4.88mm Curvature 90/50 Radius 1.52/2.79mm Chord 3.71mm Wire .15mm	Black Monofilament	8"/20cm		AA-2524N  		
			12"/30cm		AA-2525N  7799G		

Side Cutting Lancet





NEEDLE	DESCRIPTION	MATERIAL	LENGTH	SIZE			
				11-0	10-0	9-0	8-0
DSL6  (TG140-6)	3/8 Circle Length 6.15mm Curvature 135	Radius 2.54mm Chord 4.83mm Wire .15mm	Black Monofilament	6"/15cm	AA-2683N ■		
				12"/30cm	AA-2533N ■		
DSL6  (TG140-6)	3/8 Circle Length 6.15mm Curvature 135	Radius 2.54mm Chord 4.83mm Wire .15mm	Black Monofilament	12"/30cm	AA-2518N ■		
					7770G		
DSL7  (TG140-8)	3/8 Circle Length 6.60mm Curvature 131	Radius 2.79mm Chord 5.26mm Wire .20mm	Black Monofilament	12"/30cm	AA-2532N ■		
DSL7  (TG140-8)	3/8 Circle Length 6.60mm Curvature 131	Radius 2.79mm Chord 5.26mm Wire .20mm	Black Monofilament	12"/30cm	AA-2516N ■	AA-2517N ■	
					7718G	7717G	
HSL5  (TG160-6)	1/2 Circle Length 5.51mm Curvature 150	Radius 2.03mm Chord 4.07mm Wire .15mm	Black Monofilament	6"/15cm	AA-2534N ■	AA-2681N ■	
				12"/30cm	AA-2510N ■		
HSL5  (TG160-6)	1/2 Circle Length 5.51mm Curvature 150	Radius 2.03mm Chord 4.07mm Wire .15mm	Black Monofilament	6"/15cm	AA-2520N ■	AA-2521N ■	
				12"/30cm	AA-0228N ■	AA-2523N ■	
					7756G	7760G	
HSL7  (RD-1)	1/2 Circle Length 7.04mm Curvature 175	Radius 2.29mm Chord 4.71mm Wire .15mm	Black Monofilament	12"/30cm	AA-2519N ■		

Center Point Spatula



NEEDLE	DESCRIPTION	MATERIAL	LENGTH	SIZE				
				8-0	7-0	6-0	5-0	
D05  (RD-1)	1/4 Circle Length 8.00mm Curvature 90	Radius 5.10mm Chord 6.00mm Wire .33mm	Black Monofilament	18"/45cm				AA-2684N ■
								749G

Product numbers are color coded respectively as Sharpoint™ (blue), LOOK™ (purple) and Ethicon (black).
B or **N** denotes a box of 12; **D** denotes a box of 36.

Precision Reverse Cutting ▾

NEEDLE	MATERIAL	LENGTH	SIZE							
			7-0	6-0	5-0	4-0	3-0	2-0	0	
DSM11 C1  (P-1)	Black Monofilament	18"/45cm	AA-2316N 1276B 1696G	■ 1279B 697G						
		11.00mm 3/8 Circle								
DSM13 C3  (P-3)	Black Monofilament	8"/20cm		■ 1273B ■	■ 1284B ■					
		18"/45cm		AA-2176N 1282B 1698G	AA-2177N 1285B 698G	AA-2178N 1291B 699G				
	18"/45cm	Clear Monofilament			■ 1275B 690G	■ AA-691N ■				
DSM16 PC34  (PS-3)	Black Monofilament	18"/45cm		■ 1280B 1665G	AA-2181N 1283B 1668G					
DSM18 PC31  (PS-2)	Black Monofilament	18"/45cm		■ 1281B ■	■ 1288B 1666G	AA-1891N 1290B 1667G	AA-2061N ■ 1669H			
	Clear Monofilament	18"/45cm				■ AA-1611N ■	■ AA-2506N ■			
DSM24 PC33  (PS-1)	Black Monofilament	18"/45cm					■ 1294B 1663G			



Precision Conventional Cutting ▲

NEEDLE	MATERIAL	LENGTH	SIZE							
			6-0	5-0	4-0	3-0	2-0	0	1	
CP1  (PC-1)	Black Monofilament	18"/45cm			■ 1454B 1854G					
DSCM16  (PC-3)	Black Monofilament	18"/45cm	AA-2317N ■ 1866G	AA-2193N ■ ■	AA-2194N ■ 1864G					
	Black Pliable	18"/45cm		AA-2428N ■ 1965G						

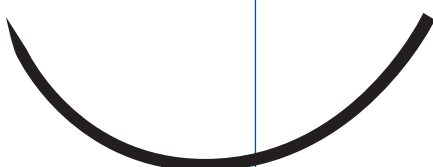
Conventional Cutting





NEEDLE	MATERIAL	LENGTH	SIZE						
			5-0	4-0	3-0	2-0	0	1	2
DSC80 80.00mm 3/8 Circle 	Black Pliable	40"/100cm				AC-2555N ■			
						■			

Reverse Cutting

NEEDLE	MATERIAL	LENGTH	SIZE						
			6-0	5-0	4-0	3-0	2-0	0	1
DS12 C17 12.00mm 3/8 Circle  (C-2)	Black Monofilament	9"/23cm	AC-2557N ■	AC-2558N ■					
		10"/25cm	911B ■	913B ■	931B ■				
	Clear Monofilament	10"/25cm		946B ■					
	Black Monofilament	18"/45cm	AC-0525N AC-0525D 916B 667G	AC-0529D 917B 668G	921B ■				
DS16 C22 16.00mm 3/8 Circle  (FS-3)	Black Monofilament	18"/45cm	AC-0181N 915B ■	AC-0556N 919B ■					
DS18 C6 18.00mm 3/8 Circle  (FS-2)	Black Monofilament	10"/25cm		945B ■	944B ■				
		18"/45cm		AC-0568N AC-0568D 918B 661G	AC-0182N AC-0182D 922B 662G	AC-0159N AC-0159D 928B ■			





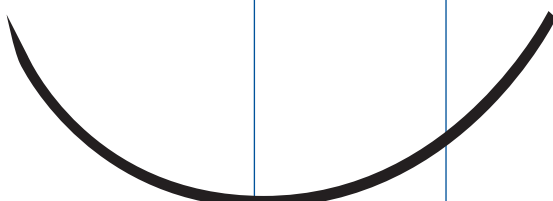





Product numbers are color coded respectively as Sharpoint™ (blue), LOOK™ (purple) and Ethicon (black).
B or **N** denotes a box of 12; **D** denotes a box of 36.

Reverse Cutting ▾







NEEDLE	MATERIAL	LENGTH	SIZE						
			6-0	5-0	4-0	3-0	2-0	0	1
DS24 C7  (FS-1)	Black Monofilament	10"/25cm			▪ 947B ▪				
		18"/45cm			AC-0584D 920B 1629H	AC-0588N 925B 663G			
	30"/75cm				AC-0586N AC-0586D ▪ 669G				
DS26 C8  (FS)	Black Monofilament	18"/45cm					AC-0597D 927B 664G		
	Blue Monofilament	30"/75cm				AC-1328N ▪ ▪	AC-1329N ▪ ▪		
C10  (FSL)	Clear Monofilament	27"/70cm				▪ 950B ▪			
DS40  (FSLX)	Blue Monofilament	30"/75cm					AC-0616N ▪	AC-0620N ▪	
							▪	▪	
DS90 	Blue Monofilament	40"/100cm						AC-0637N ▪ ▪	

Product numbers are color coded respectively as SharpPoint™ (blue), LOOK™ (purple) and Ethicon (black).
B or **N** denotes a box of 12; **D** denotes a box of 36.

Taper Point











NEEDLE	DESCRIPTION	MATERIAL	LENGTH	SIZE			
				11-0	10-0	9-0	8-0
VR5 	1/4 Circle Length 5.00mm 140 Microns Curvature 105	Black Monofilament	5"/13cm			AA-0137 	
							AA-0140 
DR4  (BV75-3)	3/8 Circle Length 4.00mm 70 Microns Curvature 135	Black Monofilament	4"/10cm	AA-0130  2881G	AA-0131 		
					AA-0133  2850G		
DR5  (BV130-4)	3/8 Circle Length 5.00mm 100 Microns Curvature 135	Black Monofilament	5"/13cm		AA-0141  2814G	AA-0142  2813G	
DR6  (BV130-5)	3/8 Circle Length 6.00mm 140 Microns Curvature 135	Black Monofilament	5"/13cm				AA-0145  2808G

VAS Cutting

NEEDLE	DESCRIPTION	MATERIAL	LENGTH	SIZE			
				11-0	10-0	9-0	8-0
HSV6 	1/2 Circle Length 6.00mm 100 Microns Curvature 149	Black Monofilament	1"/2.5cm			AA-1825 	
HSV6 	1/2 Circle Length 6.00mm 100 Microns Curvature 149	Black Monofilament	5"/13cm			AA-2545 	
VVL4 	1/4 Circle Length 4.00mm 100 Microns Curvature 109	Black Monofilament	5"/13cm			AA-2819 	

Product numbers are color coded respectively as SharpPoint™ (blue), LOOK™ (purple) and Ethicon (black).
B or **N** denotes a box of 12; **D** denotes a box of 36.

M.E.T.™ Point 

NEEDLE	DESCRIPTION	MATERIAL	LENGTH	SIZE					
				11-0	10-0	9-0	8-0		
BRM5 	Bi-Curve Length 5.00mm	70 Microns Curvature 95/107	Black Monofilament	1"/2.5cm	AA-2492 ■ ■				
		100 Microns Curvature 95/107		1"/2.5cm	AA-1824 ■ ■				
				6"/15cm	AA-2334 ■ ■				
VRM4 	1/4 Circle Length 4.00mm	70 Microns Curvature 105	Black Monofilament	4"/10cm	AA-0101 ■ ■				
VRM5 	1/4 Circle Length 5.00mm	100 Microns Curvature 105	Black Monofilament	5"/13cm	AA-0106 ■ ■				
VRM6 	1/4 Circle Length 6.00mm	140 Microns Curvature 105	Black Monofilament	5"/13cm		AA-0116 ■ ■			
DRM4 	3/8 Circle Length 4.00mm	70 Microns Curvature 135	Black Monofilament	4"/10cm	AA-0102 ■ ■	AA-0103 ■ ■			
				5"/13cm			AA-2586 ■ ■		
DRM4 	3/8 Circle Length 4.00mm	70 Microns Curvature 135	Black Monofilament	1"/2.5cm	AA-2507 ■ ■				
DRM5 	3/8 Circle Length 5.00mm	70 Microns Curvature 135	Black Monofilament	5"/13cm	AA-2547 ■ ■				
				100 Microns Curvature 135	Black Monofilament	2.5"/6.5cm		AA-2628 ■ ■	
						5"/13cm	AA-0111 ■ ■	AA-0112 ■ ■	
DRM5 	3/8 Circle Length 5.00mm	100 Microns Curvature 135	Black Monofilament	1"/2.5cm		AA-2544 ■ ■			
DRM6 	3/8 Circle Length 6.00mm	140 Microns Curvature 135	Black Monofilament	5"/13cm		AA-0121 ■ ■	AA-0122 ■ ■		
HRM4 	1/2 Circle Length 4.00mm	100 Microns Curvature 150	Black Monofilament	5"/13cm	AA-0104 ■ ■	AA-0105 ■ ■			

Product numbers are color coded respectively as SharpPoint™ (blue), LOOK™ (purple) and Ethicon (black).
B or **N** denotes a box of 12; **D** denotes a box of 36.

Straight Cutting ▾

NEEDLE	MATERIAL	LENGTH	SIZE						
			6-0	5-0	4-0	3-0	2-0	0	1
SC2 60.00mm Straight  (KS)	Black Monofilament	30"/75cm				■ 923B			
						627H			

Straight Taper Point ●



NEEDLE	MATERIAL	LENGTH	SIZE						
			6-0	5-0	4-0	3-0	2-0	0	1
S 61.00mm Straight 	Black Monofilament	30"/75cm					■ 933B		
							■		

LOOK™ Spools / Non-Sterile



MATERIAL	LENGTH	SIZE						
		6-0	5-0	4-0	3-0	2-0	0	1
Non-Absorbable Nylon, Black Monofilament	100 yards				■ SP187	■ SP188	■ SP189	■ SP190
					■	■	■	■

Product numbers are color coded respectively as Sharpoint™ (blue), LOOK™ (purple) and Ethicon (black).
B or **N** denotes a box of 12; **D** denotes a box of 36.

Side Cutting Lancet

NEEDLE	DESCRIPTION	MATERIAL	LENGTH	SIZE				
				9-0	8-0	7-0	6-0	
VSP8  (S-14, S-24)	1/4 Circle Length 8.00mm Curvature 90	Radius 5.08mm Chord 7.24mm Wire .35mm	Black Braided	18"/45cm				DA-2624N ■ 1780G
DSL6  (TG140-6)	3/8 Circle Length 6.15mm Curvature 135	Radius 2.54mm Chord 4.83mm Wire .15mm	Blue Braided Virgin	18"/45cm		DA-2552N † ■ ■		
DSL7  (TG140-8)	3/8 Circle Length 6.60mm Curvature 131	Radius 2.79mm Chord 5.26mm Wire .20mm	Black Braided	12"/30cm		DA-2526N ■ ■		
				18"/45cm		DA-2527N ■ 7733G		
			Blue Braided Virgin	18"/45cm		DA-2550N † ■ ■		











Precision Reverse Cutting

NEEDLE	MATERIAL	LENGTH	SIZE							
			8-0	7-0	6-0	5-0	4-0	3-0	2-0	
DSM7  (G-6)	7.00mm 3/8 Circle	Black Braided	12"/30cm		DA-2680N ■ ■					
DSM7  (G-6)	7.00mm 3/8 Circle	Black Braided	18"/45cm		DA-0191N ■ ■	DA-2622N ■ ■				
DSM11 C1  (P-1)	11.00mm 3/8 Circle	Black Braided	18"/45cm			DA-0187N 1260B 639G				















Product numbers are color coded respectively as SharpPoint™ (blue), LOOK™ (purple) and Ethicon (black).
B or **N** denotes a box of 12; **D** denotes a box of 36.

† Not sold in U.S.A.

Precision Reverse Cutting ▾

NEEDLE	MATERIAL	LENGTH	SIZE						
			6-0	5-0	4-0	3-0	2-0	0	1
DSM11 11.00mm 3/8 Circle  (P-1, G-1)	Black Braided	18"/45cm	DA-0188N  						
C3 13.00mm 3/8 Circle  (P-3)	Black Braided	18"/45cm		 1265B 640G	 792B 641G				
PC31 18.00mm 3/8 Circle  (PS-2)	Black Braided	18"/45cm			 1270B 1677G				
HSM8 18.00mm 1/2 Circle  (G-7)	Black Braided	18"/45cm	DA-765N  765G						

Reverse Cutting ▾



NEEDLE	MATERIAL	LENGTH	SIZE						
			6-0	5-0	4-0	3-0	2-0	0	1
C16 11.00mm 3/8 Circle  (C-2)	Black Braided	18"/45cm				 795B 			
DS12 C17 12.00mm 3/8 Circle  (C-2)	Black Braided	18"/45cm	DC-0372N 752B 	DC-0374N 774B 	 787B 736G				
DS16 C22 16.00mm 3/8 Circle  (FS-3)	Black Braided	18"/45cm	 750B 	DC-0388N DC-0388D 	DC-0239N 	DC-0389N 			
		30"/75cm			DC-0208N 				

Reverse Cutting ▾





NEEDLE	MATERIAL	LENGTH	SIZE						
			6-0	5-0	4-0	3-0	2-0	0	1
DS18 C6 	Black Braided	18"/45cm		DC-1427D 754B 682G	DC-0210N DC-0210D 781B 683G	DC-0157N DC-0157D 784B			
		30"/75cm			■ 768B ■				
DS24 C7 	Black Braided	18"/45cm			■ 776B 629G	DC-0156N DC-0156D 786B 684G	DC-0238N ■ ■		
		30"/75cm			■ 775B ■				
DS26 C8 	Black Braided	18"/45cm				DC-0211N 770B 685H			
		30"/75cm			■ DC-0212N ■				
DS30 C10 	Black Braided	18"/45cm				■ 765B 676H	■ 772B 678G		
		30"/75cm			■ DC-0413N 675H	■ DC-0415N 679H	■ DC-0417N 680H		
DS36 	Black Braided	30"/75cm				■ DC-0213N ■		■ DC-0423N ■	
C26 	Black Braided	18"/45cm		■ 779B ■	■ 777B ■	■ 778B ■			
HS16 	Black Braided	18"/45cm				■ DC-2460N ■			
C19 	Black Braided	18"/45cm				■ 783B ■			

Product numbers are color coded respectively as Sharpint™ (blue), LOOK™ (purple) and Ethicon (black).
B or **N** denotes a box of 12; **D** denotes a box of 36.

Reverse Cutting ▾

NEEDLE	MATERIAL	LENGTH	SIZE						
			6-0	5-0	4-0	3-0	2-0	0	1
C20 20.00mm 1/2 Circle  (J-1)	Black Braided	18"/45cm			■ 780B 734G				
HS24 C31 24.00mm 1/2 Circle  (X-1)	Black Braided	18"/45cm				DC-1429N 785B 632G			

Taper Point ○

NEEDLE	MATERIAL	LENGTH	SIZE						
			6-0	5-0	4-0	3-0	2-0	0	1
C21 26.00mm 1/2 Circle  (C-1)	Black Braided	18"/45cm				■ 782B ■			
DR12 12.00mm 3/8 Circle  (C-1)	Black Braided	18"/45cm	DC-2150N ■ 707G		DC-2515N ■ ■				
HR26 26.00mm 1/2 Circle  (SH)	Black Braided	30"/75cm				DC-0155N ■ K832H			
HR36 36.00mm 1/2 Circle  (MH)	White Braided	30"/75cm						DC-2543N ■ ■	

Taper Cutting Point

NEEDLE	MATERIAL	LENGTH	SIZE							
			6-0	5-0	4-0	3-0	2-0	0	1	
DRT14 14.00mm 3/8 Circle 	Black Braided	18"/45cm	DC-2530N		DC-2531N					
			■		■					

Straight Cutting

NEEDLE	MATERIAL	LENGTH	SIZE						
			6-0	5-0	4-0	3-0	2-0	0	1
GS60 SC2 60.00mm Straight  (KS)	Black Braided	30"/75cm					DC-0266D		
							■		

Pre-Cut Sutures

MATERIAL	LENGTH	SIZE						
		2-0	0	1	2	3	4	5
Silk, Black Braided Strands	8 - 24"/60cm						DG-2578N	
	13 - 24"/60cm		DG-0490N		DG-0492N			





Silk Spools / Non-Sterile

MATERIAL	LENGTH	SIZE								
		6-0	5-0	4-0	3-0	2-0	0	1	2	3
Silk, Black Braided on Spools	25 yards	■ SP102 ■	■ SP103 ■	■ SP104 ■	■ SP105 ■	■ SP106 ■				
	100 yards	■ SP114 ■	■ SP115 ■	■ SP116 ■	■ SP117 ■	■ SP118 ■	■ SP119 ■	■ SP120 ■		

Product numbers are color coded respectively as Sharpoint™ (blue), LOOK™ (purple) and Ethicon (black).
B or **N** denotes a box of 12; **D** denotes a box of 36.

POLYPROPYLENE

DermaGlide™

NEEDLE	MATERIAL	LENGTH	SIZE						
			9-0	8-0	7-0	6-0	5-0	4-0	3-0
DGL11  11.00mm 3/8 Circle (P-1)	Blue Monofilament	8"/20cm				JD-8697S ■ ■			
		18"/45cm				JD-8697 ■ 8697G	JD-8694 ■ ■		
DGL11  11.00mm 3/8 Circle (P-1)	Blue Monofilament	18"/45cm					JD-8694DA ■ ■		
DGL13  13.00mm 3/8 Circle (P-3, PC-1)	Blue Monofilament	8"/20cm				JD-8695S ■ ■	JD-8698S ■ ■	JD-8699S ■ ■	
		18"/45cm				JD-8695 ■ 8695G 8617G	JD-8698 ■ 8698G 8618G	JD-8699 ■ 8699G 8619G	
DGL19  19.00mm 3/8 Circle (PS-2, PC-5)	Blue Monofilament	8"/20cm					JD-8686S ■ ■	JD-8682S ■ ■	
		18"/45cm					JD-8686 ■ 8686G 8630G	JD-8682 ■ 8682G 8631G	JD-8687 ■ 8687H 8632G

UltraGlide™











NEEDLE	MATERIAL	LENGTH	SIZE						
			9-0	8-0	7-0	6-0	5-0	4-0	3-0
HGL5  5.51mmmm 1/2 Circle (CS160-6)	Blue Monofilament	6"/15cm	JA-2625N ■ ■						

Side Cutting Lancet



















NEEDLE	DESCRIPTION	MATERIAL	LENGTH	SIZE				
				10-0	9-0	8-0	7-0	
SSL5 	1/8 Circle Length 5.51mm Curvature 50	Radius 6.35mm Chord 5.35mm Wire .15mm	Blue Monofilament	2"/5cm	JA-2560N ■ ■			

Product numbers are color coded respectively as SharpPoint™ (blue), LOOK™ (purple) and Ethicon (black).
B or **N** denotes a box of 12; **D** denotes a box of 36.
S denotes Short Stitch.

Side Cutting Lancet 

NEEDLE	DESCRIPTION	MATERIAL	LENGTH	SIZE			
				10-0	9-0	8-0	7-0
SSL15  1/8 Circle Length 14.99 Curvature 50	Radius 16.51mm Chord 14.49mm Wire .23mm	Blue Monofilament	3"/7.5cm	JA-2559N  	JA-2558N  		
DSL6  (TG140-6)	3/8 Circle Length 6.15 Curvature 135	Blue Monofilament	12"/30cm	JA-2528N  			
HSL5  (TG160-6)	1/2 Circle Length 5.51 Curvature 150	Blue Monofilament	5"/13cm	JA-2529G  			

Precision Reverse Cutting 







NEEDLE	MATERIAL	LENGTH	SIZE							
			7-0	6-0	5-0	4-0	3-0	2-0	0	
DSM11 C1  (P-1)	Blue Monofilament	18"/45cm	JA-2468N  8696G	JA-2440N 1079B 8697G						
DSM13 C3  (P-3)	Blue Monofilament	8"/20cm		 1077B 	 1078B 					
		18"/45cm		 1082B 8695G	JA-2200N 1085B 8698G	 1091B 8699G				
DSM16  (PS-3)	Blue Monofilament	18"/45cm		 JA-2442N 8680G	 JA-2443N 8681G					
DSM18 PC31  (PS-2)	Blue Monofilament	18"/45cm			 JA-2438N 8686G	 JA-2201N 1020B 8682G	 JA-2202N 8687G			
DSM24  (PS-1)	Blue Monofilament	18"/45cm					 JA-2439N 8663G			

POLYPROPYLENE

Precision Conventional Cutting ▲





NEEDLE	MATERIAL	LENGTH	SIZE							
			6-0	5-0	4-0	3-0	2-0	0	1	
CP1 11.00mm 3/8 Circle  (PC-1)	Blue Monofilament	8"/20cm	■ 1057B ■	■ 1058B ■						

Reverse Cutting ▼



NEEDLE	MATERIAL	LENGTH	SIZE						
			6-0	5-0	4-0	3-0	2-0	0	1
C7 24.00mm 3/8 Circle  (FS-1)	Blue Monofilament	18"/45cm			■ 1095B ■				
C17 12.00mm 3/8 Circle  (C-2)	Blue Monofilament	10"/25cm	■ 1011B ■	■ 1013B ■	■ 1031B ■				
DS14 14.00mm 3/8 Circle  (FS-1)	Blue Monofilament	18"/45cm	JC-1712N ■ ■	JC-1713N ■ ■					
DS18 C6 18.00mm 3/8 Circle  (FS-2)	Blue Monofilament	18"/45cm		JC-1227D 1018B 8661G	JC-1229N JC-1229D 1022B 8683G	JC-1231N ■ ■			
DS24 24.00mm 3/8 Circle  (FS-1)	Blue Monofilament	18"/45cm				JC-1235N JC-1235D 8684G			
		30"/75cm				JC-1236D ■ ■			
DS26 26.00mm 3/8 Circle  (FS)	Blue Monofilament	18"/45cm				JC-1239N ■ ■	JC-1241D ■ 8685H		

Product numbers are color coded respectively as SharpPoint™ (blue), LOOK™ (purple) and Ethicon (black).
B or **N** denotes a box of 12; **D** denotes a box of 36.



Taper Point 

NEEDLE	MATERIAL	LENGTH	SIZE							
			8-0	7-0	6-0	5-0	4-0	3-0	0	
HRX40 40.00mm 1/2 Circle 	Blue Monofilament	40"/100cm								JC-1782N  
DRM6 6.00mm 3/8 Circle (BV-130-5) 	Blue Monofilament	5"/13cm	JA-2775N  2775G							



Taper Cutting Point 

NEEDLE	MATERIAL	LENGTH	SIZE							
			7-0	6-0	5-0	4-0	3-0	2-0	0	
HRT38 38.00mm 1/2 Circle (V-34) 	Blue Monofilament	30"/75cm								JC-1313N  

M.E.T.™ Point 

NEEDLE	DESCRIPTION	MATERIAL	LENGTH	SIZE				
				11-0	10-0	9-0	8-0	
DRM5 	3/8 Circle Length 5.00mm	100 Microns Curvature 135	Blue Monofilament	5"/13cm			JA-2123N  	

Straight Cutting 

NEEDLE	MATERIAL	LENGTH	SIZE						
			7-0	6-0	5-0	4-0	3-0	2-0	0
GS60 60.00mm Straight (KS) 	Blue Monofilament	30"/75cm							JC-1249N  

STERILIZED
POLYPROPYLENE
TAPER CUTTING
POLYVIIOLENE DERMA
POINT ULTRAGLIDE VAS
CUTTING NYLON POLYSYN FA POLY
BONEWAX TAPER POINT M.E.T. POINT
POLYSYN/POLYGLYCOLIC ACID NYLON
CUTTING LANCET DERMAGLIDE BONEWAX
PLAIN GUT ULTRAGLIDE CHROMIC GUT POLYSYN
CENTER POINT SPATULA SIDE CUTTING LANCET DERMAGLIDE
STERITAC SMALLSTITCH PLAIN GUT ULTRAGLIDE CHROMIC
PCL REVERSE CUTTING CENTER POINT SPATULA SIDE CUTTING
STRAIGHT CUTTING STERITAC SILK SMALLSTITCH PLAIN GUT UL
DERMAGLIDE POLYPROPYLENE PCL REVERSE CUTTING CENTER POINT
VAS CUTTING TAPER CUTTING STRAIGHT CUTTING STERITAC SMALLSTITCH
POLYSYN FA POLYVIIOLENE DERMAGLIDE POLYPROPYLENE PCL REVERSE CU
POINT M.E.T. POINT ULTRAGLIDE VAS CUTTING TAPER CUTTING STRAIGHT CUTTING
POLYSYN/POLYGLYCOLIC ACID NYLON POLYSYN FA POLYVIIOLENE DERMAGLIDE POL
LANCET DERMAGLIDE BONEWAX TAPER POINT M.E.T. POINT ULTRAGLIDE VAS CUTTING TAPER
ULTRAGLIDE CHROMIC GUT POLYSYN/POLYGLYCOLIC ACID NYLON POLYSYN FA POLYVIIOLENE
POINT SPATULA SIDE CUTTING LANCET DERMAGLIDE BONEWAX TAPER POINT M.E.T. POINT ULTRAGLID
SILK SMALLSTITCH PLAIN GUT ULTRAGLIDE CHROMIC GUT POLYSYN/POLYGLYCOLIC ACID NYLON POL
PCL REVERSE CUTTING CENTER POINT SPATULA SIDE CUTTING LANCET DERMAGLIDE BONEWAX TAPER POINT M.E.
STRAIGHT CUTTING STERITAC SMALLSTITCH PLAIN GUT ULTRAGLIDE CHROMIC GUT POLYSYN/POLYGLYCOLIC
DERMAGLIDE POLYPROPYLENE PCL REVERSE CUTTING CENTER POINT SPATULA SIDE CUTTING LANCET DERMAGLIDE BONE
VAS CUTTING TAPER CUTTING STRAIGHT CUTTING STERITAC SILK SMALLSTITCH PLAIN GUT ULTRAGLIDE CHROMIC GUT PO
POLYSYN FA POLYVIIOLENE DERMAGLIDE POLYPROPYLENE PCL REVERSE CUTTING CENTER POINT SPATULA SIDE CUTTING LAN
POINT M.E.T. POINT ULTRAGLIDE VAS CUTTING TAPER CUTTING STRAIGHT CUTTING STERITAC SMALLSTITCH PLAIN GUT ULTRAGLID
POLYSYN/POLYGLYCOLIC ACID NYLON POLYSYN FA POLYVIIOLENE DERMAGLIDE POLYPROPYLENE PCL REVERSE CUTTING CENTER PO
LANCET DERMAGLIDE BONEWAX TAPER POINT M.E.T. POINT ULTRAGLIDE VAS CUTTING TAPER CUTTING STRAIGHT CUTTING STERITAC SILK SMA
ULTRAGLIDE CHROMIC GUT POLYSYN/POLYGLYCOLIC ACID NYLON POLYSYN FA POLYVIIOLENE DERMAGLIDE POLYPROPYLENE PCL REVERSE CU
POINT SPATULA SIDE CUTTING LANCET DERMAGLIDE BONEWAX TAPER POINT M.E.T. POINT ULTRAGLIDE VAS CUTTING TAPER CUTTING STRAIGHT CUTTING
SMALLSTITCH PLAIN GUT ULTRAGLIDE CHROMIC GUT POLYSYN/POLYGLYCOLIC ACID NYLON POLYSYN FA POLYVIIOLENE DERMAGLIDE POLYPROPYLE
VERSE CUTTING CENTER POINT SPATULA SIDE CUTTING LANCET DERMAGLIDE BONEWAX TAPER POINT M.E.T. POINT ULTRAGLIDE VAS CUTTING TAPER CUTT
STRAIGHT CUTTING STERITAC SILK SMALLSTITCH PLAIN GUT ULTRAGLIDE CHROMIC GUT POLYSYN/POLYGLYCOLIC ACID NYLON POLYSYN FA POLYV
DERMAGLIDE POLYPROPYLENE PCL REVERSE CUTTING CENTER POINT SPATULA SIDE CUTTING LANCET DERMAGLIDE BONEWAX TAPER POINT M.E.T. PO
VAS CUTTING TAPER CUTTING STRAIGHT CUTTING STERITAC SMALLSTITCH PLAIN GUT ULTRAGLIDE CHROMIC GUT POLYSYN/POLYGLYCOLIC
POLYSYN FA POLYVIIOLENE DERMAGLIDE POLYPROPYLENE PCL REVERSE CUTTING CENTER POINT SPATULA SIDE CUTTING LANCET DERM
POINT M.E.T. POINT ULTRAGLIDE VAS CUTTING TAPER CUTTING STRAIGHT CUTTING STERITAC SILK SMALLSTITCH PLAIN GUT ULTRAGL
POLYSYN/POLYGLYCOLIC ACID NYLON POLYSYN FA POLYVIIOLENE DERMAGLIDE POLYPROPYLENE PCL REVERSE CUTTING CENT
LANCET DERMAGLIDE BONEWAX TAPER POINT M.E.T. POINT ULTRAGLIDE VAS CUTTING TAPER CUTTING STRAIGHT CUTTING ST
ULTRAGLIDE CHROMIC GUT POLYSYN/POLYGLYCOLIC ACID NYLON POLYSYN FA POLYVIIOLENE DERMAGLIDE POLYPP
POINT SPATULA SIDE CUTTING LANCET DERMAGLIDE BONEWAX TAPER POINT M.E.T. POINT ULTRAGLIDE VAS CUTTING
SILK SMALLSTITCH PLAIN GUT ULTRAGLIDE CHROMIC GUT POLYSYN/POLYGLYCOLIC ACID NYLON POLYSYN
PCL REVERSE CUTTING CENTER POINT SPATULA SIDE CUTTING LANCET DERMAGLIDE BONEWAX TAPER POINT
STRAIGHT CUTTING STERITAC SMALLSTITCH PLAIN GUT ULTRAGLIDE CHROMIC GUT POLYSYN/POI
DERMAGLIDE POLYPROPYLENE PCL REVERSE CUTTING CENTER POINT SPATULA SIDE CUTTING LAN
VAS CUTTING TAPER CUTTING STRAIGHT CUTTING STERITAC SILK SMALLSTITCH PLAIN GUT UL
POLYSYN FA POLYVIIOLENE DERMAGLIDE POLYPROPYLENE PCL REVERSE CUTTING CENT
POINT M.E.T. POINT ULTRAGLIDE VAS CUTTING TAPER CUTTING STRAIGHT CUTTING ST
POLYSYN/POLYGLYCOLIC ACID NYLON POLYSYN FA POLYVIIOLENE DERMAGLID
LANCET DERMAGLIDE BONEWAX TAPER POINT M.E.T. POINT ULTRAGLIDE VAS
ULTRAGLIDE CHROMIC GUT POLYSYN/POLYGLYCOLIC ACID NYLON PO
POINT SPATULA SIDE CUTTING LANCET DERMAGLIDE BONEWAX TAP
SMALLSTITCH PLAIN GUT ULTRAGLIDE CHROMIC GUT POLYS
VERSE CUTTING CENTER POINT SPATULA SIDE CUTTING
STRAIGHT CUTTING STERITAC SILK SMALLSTITCH PL
DERMAGLIDE POLYPROPYLENE PCL REVERSE CUTT
VAS CUTTING TAPER CUTTING STRAIGHT CUTT
POLYSYN FA POLYVIIOLENE DERMAGLID
POINT M.E.T. POINT ULTRAGLIDE VAS
POLYSYN/POLYGLYCOLIC ACID
LANCET DERMAGLIDE BONE
ULTRAGLIDE CHROMIC
POINT SPATULA SIDE
SILK SMALLST
PCL REVERSE
STRAIGHT









ADDITIONAL PRODUCTS

ADDITIONAL PRODUCTS

...L
...AGL
...AS CUTTI
...ON POLYSYN
...X TAPER POINT M.
...POLYSYN/POLYGLYCO
...CUTTING LANCET DERMAGL
...LAIN GUT ULTRAGLIDE CHROM
...CUTTING CENTER POINT SPATULA S
...GHT CUTTING STERITAC SILK SMALLSTIT
...AGLIDE POLYPROPYLENE PCL REVERSE CUTTI
...LIDE VAS CUTTING TAPER CUTTING STRAIGHT CUTTI
...OLYSYN FA POLYVIOLENE DERMAGLIDE POLYPROPYLE
...POINT M.E.T. POINT ULTRAGLIDE VAS CUTTING TAPER CUTTI
...OLYSYN/POLYGLYCOLIC ACID NYLON POLYSYN FA POLYVIOLE
...LANCET DERMAGLIDE BONEWAX TAPER POINT M.E.T. POINT ULTRAGL
...GUT ULTRAGLIDE CHROMIC GUT POLYSYN/POLYGLYCOLIC ACID NYL
...G CENTER POINT SPATULA SIDE CUTTING LANCET DERMAGLIDE BONEWAX TAP
...GHT CUTTING STERITAC SILK SMALLSTITCH PLAIN GUT ULTRAGLIDE CHROMIC C
...MAGLIDE POLYPROPYLENE PCL REVERSE CUTTING CENTER POINT SPATULA SIDE CUTTI
...GLIDE VAS CUTTING TAPER CUTTING STRAIGHT CUTTING STERITAC SMALLSTITCH PLAIN C
...LON POLYSYN FA POLYVIOLENE DERMAGLIDE POLYPROPYLENE PCL REVERSE CUTTING CEN
...AX TAPER POINT M.E.T. POINT ULTRAGLIDE VAS CUTTING TAPER CUTTING STRAIGHT CUTTING STERIT
...GUT POLYSYN/POLYGLYCOLIC ACID NYLON POLYSYN FA POLYVIOLENE DERMAGLIDE POLYPROPYLE
...CUTTING LANCET DERMAGLIDE BONEWAX TAPER POINT M.E.T. POINT ULTRAGLIDE VAS CUTTING TAPER CUTTI
...TCH PLAIN GUT ULTRAGLIDE CHROMIC GUT POLYSYN/POLYGLYCOLIC ACID NYLON POLYSYN FA POLYVIOLE
...SE CUTTING CENTER POINT SPATULA SIDE CUTTING LANCET DERMAGLIDE BONEWAX TAPER POINT M.E.T. POINT ULTRAGL
...GHT CUTTING STERITAC SILK SMALLSTITCH PLAIN GUT ULTRAGLIDE CHROMIC GUT POLYSYN/POLYGLYCOLIC ACID NYL
...MAGLIDE POLYPROPYLENE PCL REVERSE CUTTING CENTER POINT SPATULA SIDE CUTTING LANCET DERMAGLIDE BONEWAX TAP
...ENT ULTRAGLIDE VAS CUTTING TAPER CUTTING STRAIGHT CUTTING STERITAC SMALLSTITCH PLAIN GUT ULTRAGLIDE CHROMIC C
...C ACID NYLON POLYSYN FA POLYVIOLENE DERMAGLIDE POLYPROPYLENE PCL REVERSE CUTTING CENTER POINT SPATULA SIDE CUTTI
...E BONEWAX TAPER POINT M.E.T. POINT ULTRAGLIDE VAS CUTTING TAPER CUTTING STRAIGHT CUTTING STERITAC SILK SMALLSTITCH PLAIN C
...R CHROMIC GUT POLYSYN/POLYGLYCOLIC ACID NYLON POLYSYN FA POLYVIOLENE DERMAGLIDE POLYPROPYLENE PCL REVERSE CUTTING CEN
...ULA SIDE CUTTING LANCET DERMAGLIDE BONEWAX TAPER POINT M.E.T. POINT ULTRAGLIDE VAS CUTTING TAPER CUTTING STRAIGHT CUTTING STERIT
...STITCH PLAIN GUT ULTRAGLIDE CHROMIC GUT POLYSYN/POLYGLYCOLIC ACID NYLON POLYSYN FA POLYVIOLENE DERMAGLIDE POLYPROPYLENE PCL
...VERSE CUTTING CENTER POINT SPATULA SIDE CUTTING LANCET DERMAGLIDE BONEWAX TAPER POINT M.E.T. POINT ULTRAGLIDE VAS CUTTING TAPER CUTTI
...HT CUTTING STERITAC SILK SMALLSTITCH PLAIN GUT ULTRAGLIDE CHROMIC GUT POLYSYN/POLYGLYCOLIC ACID NYLON POLYSYN FA POLYVIOLE
...POLYPROPYLENE PCL REVERSE CUTTING CENTER POINT SPATULA SIDE CUTTING LANCET DERMAGLIDE BONEWAX TAPER POINT M.E.T. POINT ULTRAGL
...TAPER CUTTING STRAIGHT CUTTING STERITAC SMALLSTITCH PLAIN GUT ULTRAGLIDE CHROMIC GUT POLYSYN/POLYGLYCOLIC ACID NYL
...FINE DERMAGLIDE POLYPROPYLENE PCL REVERSE CUTTING CENTER POINT SPATULA SIDE CUTTING LANCET DERMAGLIDE BONEWAX TAP
...ULTRAGLIDE VAS CUTTING TAPER CUTTING STRAIGHT CUTTING STERITAC SILK SMALLSTITCH PLAIN GUT ULTRAGLIDE CHROMIC C
...NYLON POLYSYN FA POLYVIOLENE DERMAGLIDE POLYPROPYLENE PCL REVERSE CUTTING CENTER POINT SPATULA SIDE CUTTI
...TAPER POINT M.E.T. POINT ULTRAGLIDE VAS CUTTING TAPER CUTTING STRAIGHT CUTTING STERITAC SMALLSTITCH PLAIN C
...POLYGLYCOLIC ACID NYLON POLYSYN FA POLYVIOLENE DERMAGLIDE POLYPROPYLENE PCL REVERSE CUTTING CEN
...MAGLIDE BONEWAX TAPER POINT M.E.T. POINT ULTRAGLIDE VAS CUTTING TAPER CUTTING STRAIGHT CUTTING STERIT
...CHROMIC GUT POLYSYN/POLYGLYCOLIC ACID NYLON POLYSYN FA POLYVIOLENE DERMAGLIDE POLYPROPYLE
...CUTTING LANCET DERMAGLIDE BONEWAX TAPER POINT M.E.T. POINT ULTRAGLIDE VAS CUTTING TAPER CUTTI
...GUT ULTRAGLIDE CHROMIC GUT POLYSYN/POLYGLYCOLIC ACID NYLON POLYSYN FA POLYVIOLE
...POINT SPATULA SIDE CUTTING LANCET DERMAGLIDE BONEWAX TAPER POINT M.E.T. POINT ULTRAGL
...SMALLSTITCH PLAIN GUT ULTRAGLIDE CHROMIC GUT POLYSYN/POLYGLYCOLIC ACID NYL
...SE CUTTING CENTER POINT SPATULA SIDE CUTTING LANCET DERMAGLIDE BONEWAX TAP
...STRAIGHT CUTTING STERITAC SMALLSTITCH PLAIN GUT ULTRAGLIDE CHROMIC C
...POLYPROPYLENE PCL REVERSE CUTTING CENTER POINT SPATULA SIDE CUTTI
...TAPER CUTTING STRAIGHT CUTTING STERITAC SILK SMALLSTITCH PLAIN C
...VIOLENE DERMAGLIDE POLYPROPYLENE PCL REVERSE CUTTING CEN
...MAGLIDE VAS CUTTING TAPER CUTTING STRAIGHT CUTTING STERIT
...POLYSYN FA POLYVIOLENE DERMAGLIDE POLYPROPYLENE PCL
...NT M.E.T. POINT ULTRAGLIDE VAS CUTTING TAPER CUTTI
...YGLYCOLIC ACID NYLON POLYSYN FA POLYVIOLE
...E BONEWAX TAPER POINT M.E.T. POINT ULTRAGL
...GUT POLYSYN/POLYGLYCOLIC ACID NYL
...G LANCET DERMAGLIDE BONEWAX TAP
...IN GUT ULTRAGLIDE CHROMIC C
...TTER POINT SPATULA SIDE CUTTI
...C SMALLSTITCH PLAIN C
...RSE CUTTING CEN
...CUTTING STERIT
...YPROPYLE
...P CUTTI
...OLE

ADDITIONAL PRODUCTS

Laboratory Packs / Non-Sterile

NEEDLE	DESCRIPTION	MATERIAL	LENGTH	SIZE			
				11-0	10-0	9-0	8-0
DRM4 - M.E.T. 	3/8 Circle Length 4.00mm	70 Microns Curvature 135 Non-Absorbable Nylon Black Monofilament	5"/13cm		AK-0100 ▪		
DRM5 - M.E.T. 	3/8 Circle Length 4.00mm	100 Microns Curvature 135 Non-Absorbable Nylon Black Monofilament	5"/13cm		AK-0101 ▪		
VR5 - Taper 	1/4 Circle Length 5.00mm	140 Microns Curvature 105 Non-Absorbable Nylon Black Monofilament	5"/13cm				AK-2508 ▪
DR4 - Taper 	3/8 Circle Length 4.00mm	50 Microns Curvature 135	5"/13cm	AK-2119 ▪	AK-2120 ▪		
		70 Microns Curvature 135			AK-0105 ▪		
DR5 - Taper 	3/8 Circle Length 5.00mm	100 Microns Curvature 135 Non-Absorbable Nylon Black Monofilament	5"/13cm		AK-0106 ▪	AK-0107 ▪	
DR6 - Taper 	3/8 Circle Length 6.00mm	140 Microns Curvature 135 Non-Absorbable Nylon Black Monofilament	5"/13cm			AK-0109 ▪	AK-2546 ▪

LOOK™ Umbilical Tape/ Non-Sterile

MATERIAL	LENGTH	SIZE		
		1/8 inch	1/4 inch	3/8 inch
Umbilical Tape, 12 jars/box	20 yards	▪ UT 75 ▪	▪ UT 76 ▪	▪ UT 77 ▪

Product numbers are color coded respectively as SharpPoint™ (blue), LOOK™ (purple) and Ethicon (black).



Bone Wax

PRODUCT DESCRIPTION		PRODUCT NUMBER	
Bone Wax	Controls bleeding on bone surfaces in Thoracic, Orthopedic, Neurosurgery and Oral/Maxillofacial Surgeries	1 dozen per box / 2.5g each, ivory	901
		1 dozen per box / 2.5g each, white	902
		1 dozen per box / 2.5g each, white	903

NEW Formulation

Training Materials

PRODUCT DESCRIPTION		PRODUCT NUMBER
Video	“Microsurgical Repair of Rat Sciatic Nerve” - 1/2" VHS	82-0114
	“Microsurgical Repair of Rat Sciatic Nerve” - PAL - special order only	82-0115
Manuals	“A Laboratory Manual for Microvascular and Microtubal Surgery”	82-0116
	“Manual of Experimental Muscle Flap and Organ Transplantation Models in Rats”	82-0147
PracticePak™	Latex membrane in frame <i>(This product contains natural rubber latex which may cause allergic reactions)</i>	AK-9000

PracticeRat™ System

PRODUCT DESCRIPTION		PRODUCT NUMBER
Basic Unit 100	Platform	82-0117
Basic Unit 101	1mm Artery and vein only	82-0118
Basic Unit 102	1mm Artery and vein with adventitia	82-0119
Basic Unit 103	1mm Artery and vein with adventitia and sciatic nerve	82-0120
Artificial Blood	250cc Artificial arterial blood	82-0135
U Connector	Tubing set	82-0121

STERILE
 POLYPROPYLENE
 TAPER CUTTING
 POLYVIIOLENE DERMA
 POINT ULTRAGLIDE VAS
 NYLON POLYSYN FA
 BONEWAX TAPER POINT M.E.T. POINT
 POLYSYN/POLYGLYCOLIC ACID
 CUTTING LANCET DERMAGLIDE BONEWAX
 PLAIN GUT ULTRAGLIDE CHROMIC GUT POLYSYN
 CENTER POINT SPATULA SIDE CUTTING LANCET DERMAGLIDE
 STERITAC SMALLSTITCH PLAIN GUT ULTRAGLIDE CHROMIC
 PCL REVERSE CUTTING CENTER POINT SPATULA SIDE CUTTING
 STRAIGHT CUTTING STERITAC SILK SMALLSTITCH PLAIN GUT UL
 DERMAGLIDE POLYPROPYLENE PCL REVERSE CUTTING CENTER POINT
 VAS CUTTING TAPER CUTTING STRAIGHT CUTTING STERITAC SMALLSTITCH
 POLYSYN FA POLYVIIOLENE DERMAGLIDE POLYPROPYLENE PCL REVERSE CUTTING
 POINT M.E.T. POINT ULTRAGLIDE VAS CUTTING TAPER CUTTING STRAIGHT CUTTING
 POLYSYN/POLYGLYCOLIC ACID NYLON POLYSYN FA POLYVIIOLENE DERMAGLIDE POL
 LANCET DERMAGLIDE BONEWAX TAPER POINT M.E.T. POINT ULTRAGLIDE VAS CUTTING TAPER
 ULTRAGLIDE CHROMIC GUT POLYSYN/POLYGLYCOLIC ACID NYLON POLYSYN FA POLYVIIOLENE
 POINT SPATULA SIDE CUTTING LANCET DERMAGLIDE BONEWAX TAPER POINT M.E.T. POINT ULTRAGLIDE
 SILK SMALLSTITCH PLAIN GUT ULTRAGLIDE CHROMIC GUT POLYSYN/POLYGLYCOLIC ACID NYLON POLYSYN
 PCL REVERSE CUTTING CENTER POINT SPATULA SIDE CUTTING LANCET DERMAGLIDE BONEWAX TAPER POINT M.E.T.
 STRAIGHT CUTTING STERITAC SMALLSTITCH PLAIN GUT ULTRAGLIDE CHROMIC GUT POLYSYN/POLYGLYCOLIC ACID
 DERMAGLIDE POLYPROPYLENE PCL REVERSE CUTTING CENTER POINT SPATULA SIDE CUTTING LANCET DERMAGLIDE BONE
 VAS CUTTING TAPER CUTTING STRAIGHT CUTTING STERITAC SILK SMALLSTITCH PLAIN GUT ULTRAGLIDE CHROMIC GUT POL
 POLYSYN FA POLYVIIOLENE DERMAGLIDE POLYPROPYLENE PCL REVERSE CUTTING CENTER POINT SPATULA SIDE CUTTING LANC
 POINT M.E.T. POINT ULTRAGLIDE VAS CUTTING TAPER CUTTING STRAIGHT CUTTING STERITAC SMALLSTITCH PLAIN GUT ULTRAGLIDE
 POLYSYN/POLYGLYCOLIC ACID NYLON POLYSYN FA POLYVIIOLENE DERMAGLIDE POLYPROPYLENE PCL REVERSE CUTTING CENTER POI
 LANCET DERMAGLIDE BONEWAX TAPER POINT M.E.T. POINT ULTRAGLIDE VAS CUTTING TAPER CUTTING STRAIGHT CUTTING STERITAC SILK SMA
 ULTRAGLIDE CHROMIC GUT POLYSYN/POLYGLYCOLIC ACID NYLON POLYSYN FA POLYVIIOLENE DERMAGLIDE POLYPROPYLENE PCL REVERSE CUT
 POINT SPATULA SIDE CUTTING LANCET DERMAGLIDE BONEWAX TAPER POINT M.E.T. POINT ULTRAGLIDE VAS CUTTING TAPER CUTTING STRAIGHT CUTTING
 SMALLSTITCH PLAIN GUT ULTRAGLIDE CHROMIC GUT POLYSYN/POLYGLYCOLIC ACID NYLON POLYSYN FA POLYVIIOLENE DERMAGLIDE POLYPROPYLE
 REVERSE CUTTING CENTER POINT SPATULA SIDE CUTTING LANCET DERMAGLIDE BONEWAX TAPER POINT M.E.T. POINT ULTRAGLIDE VAS CUTTING TAPER CUTTING
 STRAIGHT CUTTING STERITAC SILK SMALLSTITCH PLAIN GUT ULTRAGLIDE CHROMIC GUT POLYSYN/POLYGLYCOLIC ACID NYLON POLYSYN FA POLYV
 DERMAGLIDE POLYPROPYLENE PCL REVERSE CUTTING CENTER POINT SPATULA SIDE CUTTING LANCET DERMAGLIDE BONEWAX TAPER POINT M.E.T. POINT
 VAS CUTTING TAPER CUTTING STRAIGHT CUTTING STERITAC SMALLSTITCH PLAIN GUT ULTRAGLIDE CHROMIC GUT POLYSYN/POLYGLYCOLIC ACID
 POLYSYN FA POLYVIIOLENE DERMAGLIDE POLYPROPYLENE PCL REVERSE CUTTING CENTER POINT SPATULA SIDE CUTTING LANCET DERM
 POINT M.E.T. POINT ULTRAGLIDE VAS CUTTING TAPER CUTTING STRAIGHT CUTTING STERITAC SILK SMALLSTITCH PLAIN GUT ULTRAGL
 POLYSYN/POLYGLYCOLIC ACID NYLON POLYSYN FA POLYVIIOLENE DERMAGLIDE POLYPROPYLENE PCL REVERSE CUTTING CENT
 LANCET DERMAGLIDE BONEWAX TAPER POINT M.E.T. POINT ULTRAGLIDE VAS CUTTING TAPER CUTTING STRAIGHT CUTTING ST
 ULTRAGLIDE CHROMIC GUT POLYSYN/POLYGLYCOLIC ACID NYLON POLYSYN FA POLYVIIOLENE DERMAGLIDE POLYPP
 POINT SPATULA SIDE CUTTING LANCET DERMAGLIDE BONEWAX TAPER POINT M.E.T. POINT ULTRAGLIDE VAS CUTTING
 SILK SMALLSTITCH PLAIN GUT ULTRAGLIDE CHROMIC GUT POLYSYN/POLYGLYCOLIC ACID NYLON POLYSYN
 PCL REVERSE CUTTING CENTER POINT SPATULA SIDE CUTTING LANCET DERMAGLIDE BONEWAX TAPER POINT
 STRAIGHT CUTTING STERITAC SMALLSTITCH PLAIN GUT ULTRAGLIDE CHROMIC GUT POLYSYN/POI
 DERMAGLIDE POLYPROPYLENE PCL REVERSE CUTTING CENTER POINT SPATULA SIDE CUTTING LANCET
 VAS CUTTING TAPER CUTTING STRAIGHT CUTTING STERITAC SILK SMALLSTITCH PLAIN GUT UL
 POLYSYN FA POLYVIIOLENE DERMAGLIDE POLYPROPYLENE PCL REVERSE CUTTING CENT
 POINT M.E.T. POINT ULTRAGLIDE VAS CUTTING TAPER CUTTING STRAIGHT CUTTING ST
 POLYSYN/POLYGLYCOLIC ACID NYLON POLYSYN FA POLYVIIOLENE DERMAGLIDE
 LANCET DERMAGLIDE BONEWAX TAPER POINT M.E.T. POINT ULTRAGLIDE VAS
 ULTRAGLIDE CHROMIC GUT POLYSYN/POLYGLYCOLIC ACID NYLON POLYSYN
 POINT SPATULA SIDE CUTTING LANCET DERMAGLIDE BONEWAX TAPER
 SMALLSTITCH PLAIN GUT ULTRAGLIDE CHROMIC GUT POLYSYN
 REVERSE CUTTING CENTER POINT SPATULA SIDE CUTTING
 STRAIGHT CUTTING STERITAC SILK SMALLSTITCH PLAIN
 DERMAGLIDE POLYPROPYLENE PCL REVERSE CUTTING
 VAS CUTTING TAPER CUTTING STRAIGHT CUTTING
 POLYSYN FA POLYVIIOLENE DERMAGLIDE
 POINT M.E.T. POINT ULTRAGLIDE VAS
 POLYSYN/POLYGLYCOLIC ACID
 LANCET DERMAGLIDE BONEWAX
 ULTRAGLIDE CHROMIC
 POINT SPATULA SIDE
 SILK SMALLSTITCH
 PCL REVERSE CUTTING
 STRAIGHT

PRODUCT INDEX

PRODUCT INDEX

...L
...AGL
...AS CUTTI
...ON POLYSYN
...X TAPER POINT M.
...POLYSYN/POLYGLYCO
...CUTTING LANCET DERMAGL
...LAIN GUT ULTRAGLIDE CHROM
...CUTTING CENTER POINT SPATULA S
...GHT CUTTING STERITAC SILK SMALLSTIT
...AGLIDE POLYPROPYLENE PCL REVERSE CUTTI
...LIDE VAS CUTTING TAPER CUTTING STRAIGHT CUTTI
...OLYSYN FA POLYVIOLENE DERMAGLIDE POLYPROPYLE
...POINT M.E.T. POINT ULTRAGLIDE VAS CUTTING TAPER CUTTI
...OLYSYN/POLYGLYCOLIC ACID NYLON POLYSYN FA POLYVIOLE
...LANCET DERMAGLIDE BONEWAX TAPER POINT M.E.T. POINT ULTRAGL
...GUT ULTRAGLIDE CHROMIC GUT POLYSYN/POLYGLYCOLIC ACID NYL
...G CENTER POINT SPATULA SIDE CUTTING LANCET DERMAGLIDE BONEWAX TAP
...GHT CUTTING STERITAC SILK SMALLSTITCH PLAIN GUT ULTRAGLIDE CHROMIC C
...MAGLIDE POLYPROPYLENE PCL REVERSE CUTTING CENTER POINT SPATULA SIDE CUTTI
...GLIDE VAS CUTTING TAPER CUTTING STRAIGHT CUTTING STERITAC SMALLSTITCH PLAIN C
...LON POLYSYN FA POLYVIOLENE DERMAGLIDE POLYPROPYLENE PCL REVERSE CUTTING CEN
...AX TAPER POINT M.E.T. POINT ULTRAGLIDE VAS CUTTING TAPER CUTTING STRAIGHT CUTTING STERIT
...GUT POLYSYN/POLYGLYCOLIC ACID NYLON POLYSYN FA POLYVIOLENE DERMAGLIDE POLYPROPYLE
...CUTTING LANCET DERMAGLIDE BONEWAX TAPER POINT M.E.T. POINT ULTRAGLIDE VAS CUTTING TAPER CUTTI
...TCH PLAIN GUT ULTRAGLIDE CHROMIC GUT POLYSYN/POLYGLYCOLIC ACID NYLON POLYSYN FA POLYVIOLE
...SE CUTTING CENTER POINT SPATULA SIDE CUTTING LANCET DERMAGLIDE BONEWAX TAPER POINT M.E.T. POINT ULTRAGL
...GHT CUTTING STERITAC SILK SMALLSTITCH PLAIN GUT ULTRAGLIDE CHROMIC GUT POLYSYN/POLYGLYCOLIC ACID NYL
...MAGLIDE POLYPROPYLENE PCL REVERSE CUTTING CENTER POINT SPATULA SIDE CUTTING LANCET DERMAGLIDE BONEWAX TAP
...ENT ULTRAGLIDE VAS CUTTING TAPER CUTTING STRAIGHT CUTTING STERITAC SMALLSTITCH PLAIN GUT ULTRAGLIDE CHROMIC C
...C ACID NYLON POLYSYN FA POLYVIOLENE DERMAGLIDE POLYPROPYLENE PCL REVERSE CUTTING CENTER POINT SPATULA SIDE CUTTI
...E BONEWAX TAPER POINT M.E.T. POINT ULTRAGLIDE VAS CUTTING TAPER CUTTING STRAIGHT CUTTING STERITAC SILK SMALLSTITCH PLAIN C
...MOMIC GUT POLYSYN/POLYGLYCOLIC ACID NYLON POLYSYN FA POLYVIOLENE DERMAGLIDE POLYPROPYLENE PCL REVERSE CUTTING CEN
...ULA SIDE CUTTING LANCET DERMAGLIDE BONEWAX TAPER POINT M.E.T. POINT ULTRAGLIDE VAS CUTTING TAPER CUTTING STRAIGHT CUTTING STERIT
...LSTITCH PLAIN GUT ULTRAGLIDE CHROMIC GUT POLYSYN/POLYGLYCOLIC ACID NYLON POLYSYN FA POLYVIOLENE DERMAGLIDE POLYPROPYLENE PCL REVERSE CUTTING CEN
...RSE CUTTING CENTER POINT SPATULA SIDE CUTTING LANCET DERMAGLIDE BONEWAX TAPER POINT M.E.T. POINT ULTRAGLIDE VAS CUTTING TAPER CUTTI
...HT CUTTING STERITAC SILK SMALLSTITCH PLAIN GUT ULTRAGLIDE CHROMIC GUT POLYSYN/POLYGLYCOLIC ACID NYLON POLYSYN FA POLYVIOLE
...POLYPROPYLENE PCL REVERSE CUTTING CENTER POINT SPATULA SIDE CUTTING LANCET DERMAGLIDE BONEWAX TAPER POINT M.E.T. POINT ULTRAGL
...TAPER CUTTING STRAIGHT CUTTING STERITAC SMALLSTITCH PLAIN GUT ULTRAGLIDE CHROMIC GUT POLYSYN/POLYGLYCOLIC ACID NYL
...NE DERMAGLIDE POLYPROPYLENE PCL REVERSE CUTTING CENTER POINT SPATULA SIDE CUTTING LANCET DERMAGLIDE BONEWAX TAP
...ULTRAGLIDE VAS CUTTING TAPER CUTTING STRAIGHT CUTTING STERITAC SILK SMALLSTITCH PLAIN GUT ULTRAGLIDE CHROMIC C
...NYLON POLYSYN FA POLYVIOLENE DERMAGLIDE POLYPROPYLENE PCL REVERSE CUTTING CENTER POINT SPATULA SIDE CUTTI
...TAPER POINT M.E.T. POINT ULTRAGLIDE VAS CUTTING TAPER CUTTING STRAIGHT CUTTING STERITAC SMALLSTITCH PLAIN C
...POLYGLYCOLIC ACID NYLON POLYSYN FA POLYVIOLENE DERMAGLIDE POLYPROPYLENE PCL REVERSE CUTTING CEN
...MAGLIDE BONEWAX TAPER POINT M.E.T. POINT ULTRAGLIDE VAS CUTTING TAPER CUTTING STRAIGHT CUTTING STERIT
...MOMIC GUT POLYSYN/POLYGLYCOLIC ACID NYLON POLYSYN FA POLYVIOLENE DERMAGLIDE POLYPROPYLE
...CUTTING LANCET DERMAGLIDE BONEWAX TAPER POINT M.E.T. POINT ULTRAGLIDE VAS CUTTING TAPER CUTTI
...GUT ULTRAGLIDE CHROMIC GUT POLYSYN/POLYGLYCOLIC ACID NYLON POLYSYN FA POLYVIOLE
...POINT SPATULA SIDE CUTTING LANCET DERMAGLIDE BONEWAX TAPER POINT M.E.T. POINT ULTRAGL
...SMALLSTITCH PLAIN GUT ULTRAGLIDE CHROMIC GUT POLYSYN/POLYGLYCOLIC ACID NYL
...SE CUTTING CENTER POINT SPATULA SIDE CUTTING LANCET DERMAGLIDE BONEWAX TAP
...STRAIGHT CUTTING STERITAC SMALLSTITCH PLAIN GUT ULTRAGLIDE CHROMIC C
...POLYPROPYLENE PCL REVERSE CUTTING CENTER POINT SPATULA SIDE CUTTI
...TAPER CUTTING STRAIGHT CUTTING STERITAC SILK SMALLSTITCH PLAIN C
...VIOLENE DERMAGLIDE POLYPROPYLENE PCL REVERSE CUTTING CEN
...MAGLIDE VAS CUTTING TAPER CUTTING STRAIGHT CUTTING STERIT
...POLYSYN FA POLYVIOLENE DERMAGLIDE POLYPROPYLENE PCL REVERSE CUTTING CEN
...NT M.E.T. POINT ULTRAGLIDE VAS CUTTING TAPER CUTTI
...YGLYCOLIC ACID NYLON POLYSYN FA POLYVIOLE
...BONEWAX TAPER POINT M.E.T. POINT ULTRAGL
...GUT POLYSYN/POLYGLYCOLIC ACID NYL
...G LANCET DERMAGLIDE BONEWAX TAP
...IN GUT ULTRAGLIDE CHROMIC C
...TTER POINT SPATULA SIDE CUTTI
...C SMALLSTITCH PLAIN C
...RSE CUTTING CEN
...CUTTING STERIT
...YPROPYLE
...P CUTTI
...OLE

PRODUCT INDEX

Suture

CODE	SIZE	MATERIAL	PAGE NUMBER
311B	3-0	POLYSYN/POLYGLYCOLIC ACID, Violet Braided	24
316B	3-0	POLYSYN/POLYGLYCOLIC ACID, Violet Braided	24
317B	2-0	POLYSYN/POLYGLYCOLIC ACID, Violet Braided	24
332B	3-0	POLYSYN/POLYGLYCOLIC ACID, Violet Braided	24
333B	2-0	POLYSYN/POLYGLYCOLIC ACID, Violet Braided	24
339B	2-0	POLYSYN/POLYGLYCOLIC ACID, Violet Braided	25
340B	0	POLYSYN/POLYGLYCOLIC ACID, Violet Braided	25
341B	1	POLYSYN/POLYGLYCOLIC ACID, Violet Braided	25
352B	0	POLYSYN/POLYGLYCOLIC ACID, Violet Braided	25
353B	1	POLYSYN/POLYGLYCOLIC ACID, Violet Braided	25
386B	4-0	POLYSYN/POLYGLYCOLIC ACID, Undyed Braided	23
421B	5-0	POLYSYN/POLYGLYCOLIC ACID, Undyed Braided	23
422B	4-0	POLYSYN/POLYGLYCOLIC ACID, Undyed Braided	23
423B	3-0	POLYSYN/POLYGLYCOLIC ACID, Undyed Braided	23
441B	4-0	POLYSYN/POLYGLYCOLIC ACID, Undyed Braided	23
442B	3-0	POLYSYN/POLYGLYCOLIC ACID, Undyed Braided	23
443B	2-0	POLYSYN/POLYGLYCOLIC ACID, Undyed Braided	23
480B	1	POLYSYN/POLYGLYCOLIC ACID, Violet Braided	24
492B	6-0	POLYSYN/POLYGLYCOLIC ACID, Undyed Braided	21
493B	5-0	POLYSYN/POLYGLYCOLIC ACID, Undyed Braided	21
494B	4-0	POLYSYN/POLYGLYCOLIC ACID, Undyed Braided	21
495B	5-0	POLYSYN/POLYGLYCOLIC ACID, Undyed Braided	22
496B	4-0	POLYSYN/POLYGLYCOLIC ACID, Undyed Braided	22
497B	3-0	POLYSYN/POLYGLYCOLIC ACID, Undyed Braided	22
500B	5-0	PLAIN GUT	12
521B	5-0	PLAIN GUT	12
525B	3-0	CHROMIC GUT	14
531B	4-0	PLAIN GUT	12
535B	5-0	PLAIN GUT	12
536B	4-0	PLAIN GUT	12
537B	4-0	PLAIN GUT	12
543B	5-0	CHROMIC GUT	14
544B	4-0	CHROMIC GUT	14
546B	4-0	CHROMIC GUT	14
547B	4-0	CHROMIC GUT	14
550B	5-0	PLAIN GUT	12
551B	4-0	PLAIN GUT	12
553B	3-0	PLAIN GUT	12
554B	3-0	PLAIN GUT	12
555B	2-0	PLAIN GUT	12
557B	5-0	CHROMIC GUT	14
558B	4-0	CHROMIC GUT	14
559B	4-0	CHROMIC GUT	14
560B	3-0	CHROMIC GUT	14
561B	2-0	CHROMIC GUT	14
562B	0	CHROMIC GUT	14
563B	5-0	CHROMIC GUT	14
589B	4-0	CHROMIC GUT	15
590B	5-0	CHROMIC GUT	15
591B	4-0	PLAIN GUT	12

Suture

CODE	SIZE	MATERIAL	PAGE NUMBER
592B	3-0	PLAIN GUT	12
593B	3-0	PLAIN GUT	12
594B	3-0	PLAIN GUT	12
595B	4-0	CHROMIC GUT	13
596B	5-0	PLAIN GUT	11
598B	5-0	CHROMIC GUT	14
599B	4-0	PLAIN GUT	12
683B	3-0	POLYSYN/POLYGLYCOLIC ACID, Undyed Braided	22
750B	6-0	SILK, Black Braided	46
752B	6-0	SILK, Black Braided	46
754B	5-0	SILK, Black Braided	47
765B	3-0	SILK, Black Braided	47
768B	3-0	SILK, Black Braided	47
770B	2-0	SILK, Black Braided	47
772B	0	SILK, Black Braided	47
774B	5-0	SILK, Black Braided	46
775B	3-0	SILK, Black Braided	47
776B	4-0	SILK, Black Braided	47
777B	4-0	SILK, Black Braided	47
778B	3-0	SILK, Black Braided	47
779B	5-0	SILK, Black Braided	47
780B	4-0	SILK, Black Braided	48
781B	4-0	SILK, Black Braided	47
782B	3-0	SILK, Black Braided	48
783B	3-0	SILK, Black Braided	47
784B	3-0	SILK, Black Braided	47
785B	3-0	SILK, Black Braided	48
786B	3-0	SILK, Black Braided	47
787B	4-0	SILK, Black Braided	46
792B	4-0	SILK, Black Braided	46
795B	3-0	SILK, Black Braided	46
797B	5-0	POLYVIOLINE/POLYESTER, Green Braided	33
911B	6-0	NYLON, Black Monofilament	39
913B	5-0	NYLON, Black Monofilament	39
915B	6-0	NYLON, Black Monofilament	39
916B	6-0	NYLON, Black Monofilament	39
917B	5-0	NYLON, Black Monofilament	39
918B	5-0	NYLON, Black Monofilament	39
919B	5-0	NYLON, Black Monofilament	39
920B	4-0	NYLON, Black Monofilament	40
921B	4-0	NYLON, Black Monofilament	39
922B	4-0	NYLON, Black Monofilament	39
923B	3-0	NYLON, Black Monofilament	43
925B	3-0	NYLON, Black Monofilament	40
927B	2-0	NYLON, Black Monofilament	40
928B	3-0	NYLON, Black Monofilament	39
931B	4-0	NYLON, Black Monofilament	39
933B	2-0	NYLON, Black Monofilament	43
944B	4-0	NYLON, Black Monofilament	39
945B	5-0	NYLON, Black Monofilament	39

PRODUCT INDEX

Suture

CODE	SIZE	MATERIAL	PAGE NUMBER
946B	5-0	NYLON, Clear Monofilament	39
947B	4-0	NYLON, Black Monofilament	40
950B	3-0	NYLON, Clear Monofilament	40
1011B	6-0	POLYPROPYLENE, Blue Monofilament	53
1013B	5-0	POLYPROPYLENE, Blue Monofilament	53
1018B	5-0	POLYPROPYLENE, Blue Monofilament	53
1020B	4-0	POLYPROPYLENE, Blue Monofilament	52
1022B	4-0	POLYPROPYLENE, Blue Monofilament	53
1031B	4-0	POLYPROPYLENE, Blue Monofilament	53
1057B	6-0	POLYPROPYLENE, Blue Monofilament	53
1058B	5-0	POLYPROPYLENE, Blue Monofilament	53
1077B	6-0	POLYPROPYLENE, Blue Monofilament	52
1078B	5-0	POLYPROPYLENE, Blue Monofilament	52
1079B	6-0	POLYPROPYLENE, Blue Monofilament	52
1082B	6-0	POLYPROPYLENE, Blue Monofilament	52
1085B	5-0	POLYPROPYLENE, Blue Monofilament	52
1091B	4-0	POLYPROPYLENE, Blue Monofilament	52
1095B	4-0	POLYPROPYLENE, Blue Monofilament	53
1176B	5-0	POLYVIOLENE/POLYESTER, Green Braided	33
1180B	4-0	POLYVIOLENE/POLYESTER, Green Braided	33
1205B	4-0	POLYVIOLENE/POLYESTER, White Braided	33
1241B	4-0	PLAIN GUT	11
1242B	6-0	CHROMIC GUT	13
1248B	5-0	CHROMIC GUT	13
1253B	4-0	CHROMIC GUT	13
1260B	6-0	SILK, Black Braided	45
1265B	5-0	SILK, Black Braided	46
1270B	4-0	SILK, Black Braided	46
1273B	6-0	NYLON, Black Monofilament	38
1275B	5-0	NYLON, Clear Monofilament	38
1276B	7-0	NYLON, Black Monofilament	38
1279B	6-0	NYLON, Black Monofilament	38
1280B	6-0	NYLON, Black Monofilament	38
1281B	6-0	NYLON, Black Monofilament	38
1282B	6-0	NYLON, Black Monofilament	38
1283B	5-0	NYLON, Black Monofilament	38
1284B	5-0	NYLON, Black Monofilament	38
1285B	5-0	NYLON, Black Monofilament	38
1288B	5-0	NYLON, Black Monofilament	38
1290B	4-0	NYLON, Black Monofilament	38
1291B	4-0	NYLON, Black Monofilament	38
1294B	3-0	NYLON, Black Monofilament	38
1415B	6-0	PLAIN GUT	11
1454B	4-0	NYLON, Black Monofilament	38
AA-691N	4-0	NYLON, Clear Monofilament	38
AA-0101	10-0	NYLON, Black Monofilament	42
AA-0102	11-0	NYLON, Black Monofilament	42
AA-0103	10-0	NYLON, Black Monofilament	42
AA-0104	10-0	NYLON, Black Monofilament	42
AA-0105	9-0	NYLON, Black Monofilament	42

Suture

CODE	SIZE	MATERIAL	PAGE NUMBER
AA-0106	10-0	NYLON, Black Monofilament	42
AA-0111	10-0	NYLON, Black Monofilament	42
AA-0112	9-0	NYLON, Black Monofilament	42
AA-0116	9-0	NYLON, Black Monofilament	42
AA-0121	9-0	NYLON, Black Monofilament	42
AA-0122	8-0	NYLON, Black Monofilament	42
AA-0130	11-0	NYLON, Black Monofilament	41
AA-0131	10-0	NYLON, Black Monofilament	41
AA-0133	10-0	NYLON, Black Monofilament	41
AA-0137	9-0	NYLON, Black Monofilament	41
AA-0140	8-0	NYLON, Black Monofilament	41
AA-0141	10-0	NYLON, Black Monofilament	41
AA-0142	9-0	NYLON, Black Monofilament	41
AA-0145	8-0	NYLON, Black Monofilament	41
AA-0228N	10-0	NYLON, Black Monofilament	37
AA-1611N	4-0	NYLON, Clear Monofilament	38
AA-1824	10-0	NYLON, Black Monofilament	42
AA-1825	9-0	NYLON, Black Monofilament	41
AA-1891N	4-0	NYLON, Black Monofilament	38
AA-2061N	3-0	NYLON, Black Monofilament	38
AA-2176N	6-0	NYLON, Black Monofilament	38
AA-2177N	5-0	NYLON, Black Monofilament	38
AA-2178N	4-0	NYLON, Black Monofilament	38
AA-2181N	5-0	NYLON, Black Monofilament	38
AA-2193N	5-0	NYLON, Black Monofilament	38
AA-2194N	4-0	NYLON, Black Monofilament	38
AA-2316N	7-0	NYLON, Black Monofilament	38
AA-2317N	6-0	NYLON, Black Monofilament	38
AA-2334	10-0	NYLON, Black Monofilament	42
AA-2428N	5-0	NYLON, Black Pliable	38
AA-2492	10-0	NYLON, Black Monofilament	42
AA-2506N	3-0	NYLON, Clear Monofilament	38
AA-2507	10-0	NYLON, Black Monofilament	42
AA-2510N	10-0	NYLON, Black Monofilament	37
AA-2516N	10-0	NYLON, Black Monofilament	37
AA-2517N	9-0	NYLON, Black Monofilament	37
AA-2518N	10-0	NYLON, Black Monofilament	37
AA-2519N	10-0	NYLON, Black Monofilament	37
AA-2520N	11-0	NYLON, Black Monofilament	37
AA-2521N	10-0	NYLON, Black Monofilament	37
AA-2522N	10-0	NYLON, Black Monofilament	36
AA-2523N	9-0	NYLON, Black Monofilament	37
AA-2524N	10-0	NYLON, Black Monofilament	36
AA-2525N	10-0	NYLON, Black Monofilament	36
AA-2532N	10-0	NYLON, Black Monofilament	37
AA-2533N	10-0	NYLON, Black Monofilament	37
AA-2534N	10-0	NYLON, Black Monofilament	37
AA-2544	9-0	NYLON, Black Monofilament	42
AA-2545	9-0	NYLON, Black Monofilament	41
AA-2547	10-0	NYLON, Black Monofilament	42

PRODUCT INDEX

Suture

CODE	SIZE	MATERIAL	PAGE NUMBER
AA-2586	9-0	NYLON, Black Monofilament	42
AA-2626N	10-0	NYLON, Black Monofilament	36
AA-2627N	10-0	NYLON, Black Monofilament	36
AA-2628	9-0	NYLON, Black Monofilament	42
AA-2673N	10-0	NYLON, Black Monofilament	36
AA-2674N	10-0	NYLON, Black Monofilament	36
AA-2675N	10-0	NYLON, Black Monofilament	36
AA-2681N	9-0	NYLON, Black Monofilament	37
AA-2683N	10-0	NYLON, Black Monofilament	37
AA-2684N	5-0	NYLON, Black Monofilament	37
AA-2687N	10-0	NYLON, Black Monofilament	36
AA-2712N	10-0	NYLON, Black Monofilament	36
AA-2713N	11-0	NYLON, Black Monofilament	36
AA-2714N	10-0	NYLON, Black Monofilament	36
AA-2819	9-0	NYLON, Black Monofilament	41
AC-0159D	3-0	NYLON, Black Monofilament	39
AC-0159N	3-0	NYLON, Black Monofilament	39
AC-0181N	6-0	NYLON, Black Monofilament	39
AC-0182D	4-0	NYLON, Black Monofilament	39
AC-0182N	4-0	NYLON, Black Monofilament	39
AC-0525D	6-0	NYLON, Black Monofilament	39
AC-0525N	6-0	NYLON, Black Monofilament	39
AC-0529D	5-0	NYLON, Black Monofilament	39
AC-0556N	5-0	NYLON, Black Monofilament	39
AC-0568D	5-0	NYLON, Black Monofilament	39
AC-0568N	5-0	NYLON, Black Monofilament	39
AC-0584D	4-0	NYLON, Black Monofilament	40
AC-0586D	3-0	NYLON, Black Monofilament	40
AC-0586N	3-0	NYLON, Black Monofilament	40
AC-0588N	3-0	NYLON, Black Monofilament	40
AC-0597D	2-0	NYLON, Black Monofilament	40
AC-0616N	2-0	NYLON, Blue Monofilament	40
AC-0620N	1	NYLON, Blue Monofilament	40
AC-0637N	1	NYLON, Blue Monofilament	40
AC-1328N	3-0	NYLON, Blue Monofilament	40
AC-1329N	2-0	NYLON, Blue Monofilament	40
AC-2555N	2-0	NYLON, Black Pliable	39
AC-2557N	6-0	NYLON, Black Monofilament	39
AC-2558N	5-0	NYLON, Black Monofilament	39
AD-697N	6-0	NYLON, Black Monofilament	35
AD-697S	6-0	NYLON, Black Monofilament	35
AD-698N	5-0	NYLON, Black Monofilament	35
AD-698S	5-0	NYLON, Black Monofilament	35
AD-699N	4-0	NYLON, Black Monofilament	35
AD-699S	4-0	NYLON, Black Monofilament	35
AD-1661	5-0	NYLON, Black Monofilament	35
AD-1662	4-0	NYLON, Black Monofilament	35
AD-1666	5-0	NYLON, Black Monofilament	35
AD-1666S	5-0	NYLON, Black Monofilament	35
AD-1667	4-0	NYLON, Black Monofilament	35

Suture

CODE	SIZE	MATERIAL	PAGE NUMBER
AD-1667S	4-0	NYLON, Black Monofilament	35
AD-1696	7-0	NYLON, Black Monofilament	35
AD-1698	6-0	NYLON, Black Monofilament	35
AD-1698S	6-0	NYLON, Black Monofilament	35
AD-1956N	6-0	NYLON, Black Pliable	35
BA-770N	6-0	PLAIN GUT	11
BA-2415N	6-0	PLAIN GUT	11
BA-2698N	6-0	PLAIN GUT	11
BA-2711N	6-0	PLAIN GUT	11
BC-1102D	4-0	PLAIN GUT	12
BC-1103D	3-0	PLAIN GUT	12
BC-1106D	3-0	PLAIN GUT	12
BC-2463N	4-0	PLAIN GUT	12
BD-660N	6-0	PLAIN GUT	11
CA-2417N	3-0	CHROMIC GUT	13
CC-0153N	3-0	CHROMIC GUT	15
CC-0204N	3-0	CHROMIC GUT	15
CC-0242N	3-0	CHROMIC GUT	15
CC-0244N	2-0	CHROMIC GUT	15
CC-0245N	0	CHROMIC GUT	15
CC-0272N	2-0	CHROMIC GUT	15
CC-0302N	4-0	CHROMIC GUT	15
CC-0935N	5-0	CHROMIC GUT	14
CC-0937D	3-0	CHROMIC GUT	14
CD-687DA	5-0	CHROMIC GUT	13
CG-2758N	3	CHROMIC GUT, Suture Strand	15
DA-0187N	6-0	SILK, Black Braided	45
DA-0188N	6-0	SILK, Black Braided	46
DA-0191N	7-0	SILK, Black Braided	45
DA-765N	6-0	SILK, Black Braided	46
DA-2526N	8-0	SILK, Black Braided	45
DA-2527N	7-0	SILK, Black Braided	45
DA-2550N	8-0	SILK, Blue Braided	45
DA-2552N	8-0	SILK, Blue Braided	45
DA-2622N	6-0	SILK, Black Braided	45
DA-2624N	6-0	SILK, Black Braided	45
DA-2680N	7-0	SILK, Black Braided	45
DC-0155N	3-0	SILK, Black Braided	48
DC-0156D	3-0	SILK, Black Braided	47
DC-0156N	3-0	SILK, Black Braided	47
DC-0157D	3-0	SILK, Black Braided	47
DC-0157N	3-0	SILK, Black Braided	47
DC-0210D	4-0	SILK, Black Braided	47
DC-0210N	4-0	SILK, Black Braided	47
DC-0211N	2-0	SILK, Black Braided	47
DC-0212N	3-0	SILK, Black Braided	47
DC-0213N	2-0	SILK, Black Braided	47
DC-0238N	2-0	SILK, Black Braided	47
DC-0239N	4-0	SILK, Black Braided	46
DC-0266D	2-0	SILK, Black Braided	49

PRODUCT INDEX

Suture

CODE	SIZE	MATERIAL	PAGE NUMBER
DC-0372N	6-0	SILK, Black Braided	46
DC-0388D	5-0	SILK, Black Braided	46
DC-0388N	5-0	SILK, Black Braided	46
DC-0389N	3-0	SILK, Black Braided	46
DC-0413N	3-0	SILK, Black Braided	47
DC-0415N	2-0	SILK, Black Braided	47
DC-0417N	0	SILK, Black Braided	47
DC-0423N	1	SILK, Black Braided	47
DC-1427D	5-0	SILK, Black Braided	47
DC-1429N	3-0	SILK, Black Braided	48
DC-2150N	6-0	SILK, Black Braided	48
DC-2460N	3-0	SILK, Black Braided	47
DC-2515N	4-0	SILK, Black Braided	48
DC-2530N	6-0	SILK, Black Braided	49
DC-2531N	4-0	SILK, Black Braided	49
DC-2543N	1	SILK, White Braided	48
DG-0490N	0	SILK, Black Braided Strands	49
DG-0492N	2	SILK, Black Braided Strands	49
DG-2578N	4	SILK, Black Braided Strands	49
FA-691N	4-0	POLYVIOLENE/POLYESTER, White Braided	33
FC-2600N	4-0	POLYVIOLENE/POLYESTER, Green Braided	33
FC-2678N	3-0	POLYVIOLENE/POLYESTER, Green Braided	33
GA-401N	8-0	POLYSYN/POLYGLYCOLIC ACID, Violet Braided	23
GA-405N	8-0	POLYSYN/POLYGLYCOLIC ACID, Violet Braided	23
GA-426N	4-0	POLYSYN/POLYGLYCOLIC ACID, Undyed Braided	22
GA-427N	3-0	POLYSYN/POLYGLYCOLIC ACID, Undyed Braided	22
GA-446N	6-0	POLYSYN/POLYGLYCOLIC ACID, Violet Braided	23
GA-448N	10-0	POLYSYN/POLYGLYCOLIC ACID, Violet Monofilament	20
GA-449N	9-0	POLYSYN/POLYGLYCOLIC ACID, Undyed Braided	19
GA-460N	10-0	POLYSYN/POLYGLYCOLIC ACID, Violet Monofilament	20
GA-462N	10-0	POLYSYN/POLYGLYCOLIC ACID, Violet Monofilament	20
GA-463N	4-0	POLYSYN/POLYGLYCOLIC ACID, Violet Braided	21
GA-490N	5-0	POLYSYN/POLYGLYCOLIC ACID, Undyed Braided	21
GA-499N	6-0	POLYSYN/POLYGLYCOLIC ACID, Undyed Braided	22
GA-500N	5-0	POLYSYN/POLYGLYCOLIC ACID, Undyed Braided	22
GA-507N	4-0	POLYSYN/POLYGLYCOLIC ACID, Undyed Braided	22
GA-544N	6-0	POLYSYN/POLYGLYCOLIC ACID, Violet Braided	20
GA-546N	7-0	POLYSYN/POLYGLYCOLIC ACID, Violet Braided	21
GA-547N	8-0	POLYSYN/POLYGLYCOLIC ACID, Violet Braided	21
GA-548N	8-0	POLYSYN/POLYGLYCOLIC ACID, Violet Braided	21
GA-552N	5-0	POLYSYN/POLYGLYCOLIC ACID, Violet Braided	21
GA-553N	6-0	POLYSYN/POLYGLYCOLIC ACID, Violet Braided	21
GA-555N	6-0	POLYSYN/POLYGLYCOLIC ACID, Violet Braided	20
GA-556N	6-0	POLYSYN/POLYGLYCOLIC ACID, Violet Braided	20
GA-566N	7-0	POLYSYN/POLYGLYCOLIC ACID, Violet Braided	21
GA-570N	6-0	POLYSYN/POLYGLYCOLIC ACID, Violet Braided	20
GA-574N	8-0	POLYSYN/POLYGLYCOLIC ACID, Violet Braided	21
GA-575N	7-0	POLYSYN/POLYGLYCOLIC ACID, Violet Braided	21
GA-590N	8-0	POLYSYN/POLYGLYCOLIC ACID, Violet Braided	20
GA-670N	6-0	POLYSYN/POLYGLYCOLIC ACID, Undyed Braided	20

Suture

CODE	SIZE	MATERIAL	PAGE NUMBER
GA-671N	5-0	POLYSYN/POLYGLYCOLIC ACID, Undyed Braided	20
GA-834N	5-0	POLYSYN/POLYGLYCOLIC ACID, Undyed Braided	22
GA-845N	4-0	POLYSYN/POLYGLYCOLIC ACID, Undyed Braided	22
GA-960N	10-0	POLYSYN/POLYGLYCOLIC ACID, Violet Monofilament	20
GA-966N	10-0	POLYSYN/POLYGLYCOLIC ACID, Violet Monofilament	19
GA-974N	8-0	POLYSYN/POLYGLYCOLIC ACID, Violet Braided	21
GA-980N	10-0	POLYSYN/POLYGLYCOLIC ACID, Violet Monofilament	19
GA-0508N	3-0	POLYSYN/POLYGLYCOLIC ACID, Undyed Braided	22
GA-7498N	10-0	POLYSYN/POLYGLYCOLIC ACID, Violet Monofilament	23
GC-214N	4-0	POLYSYN/POLYGLYCOLIC ACID, Undyed Braided	24
GC-232N	3-0	POLYSYN/POLYGLYCOLIC ACID, Undyed Braided	24
GC-259N	6-0	POLYSYN/POLYGLYCOLIC ACID, Undyed Braided	25
GC-260N	5-0	POLYSYN/POLYGLYCOLIC ACID, Undyed Braided	25
GC-269N	2-0	POLYSYN/POLYGLYCOLIC ACID, Undyed Braided	24
GC-391N	5-0	POLYSYN/POLYGLYCOLIC ACID, Violet Braided	24
GC-392N	4-0	POLYSYN/POLYGLYCOLIC ACID, Violet Braided	24
GC-393N	3-0	POLYSYN/POLYGLYCOLIC ACID, Violet Braided	23
GC-416N	7-0	POLYSYN/POLYGLYCOLIC ACID, Undyed Braided	24
GC-417N	6-0	POLYSYN/POLYGLYCOLIC ACID, Undyed Braided	24
GC-945N	6-0	POLYSYN/POLYGLYCOLIC ACID, Undyed Braided	25
GD-489S	6-0	POLYSYN/POLYGLYCOLIC ACID, Undyed Braided	19
GD-492N	6-0	POLYSYN/POLYGLYCOLIC ACID, Undyed Braided	19
GD-492S	6-0	POLYSYN/POLYGLYCOLIC ACID, Undyed Braided	19
GD-493N	5-0	POLYSYN/POLYGLYCOLIC ACID, Undyed Braided	19
GD-493S	5-0	POLYSYN/POLYGLYCOLIC ACID, Undyed Braided	19
GD-494N	4-0	POLYSYN/POLYGLYCOLIC ACID, Undyed Braided	19
GD-494S	4-0	POLYSYN/POLYGLYCOLIC ACID, Undyed Braided	19
GD-495N	5-0	POLYSYN/POLYGLYCOLIC ACID, Undyed Braided	19
GD-495S	5-0	POLYSYN/POLYGLYCOLIC ACID, Undyed Braided	19
GD-496N	4-0	POLYSYN/POLYGLYCOLIC ACID, Undyed Braided	19
GD-496S	4-0	POLYSYN/POLYGLYCOLIC ACID, Undyed Braided	19
GD-497N	3-0	POLYSYN/POLYGLYCOLIC ACID, Undyed Braided	19
GD-503N	5-0	POLYSYN/POLYGLYCOLIC ACID, Undyed Braided	19
GD-504N	4-0	POLYSYN/POLYGLYCOLIC ACID, Undyed Braided	19
GD-506N	5-0	POLYSYN/POLYGLYCOLIC ACID, Undyed Braided	19
GD-507N	4-0	POLYSYN/POLYGLYCOLIC ACID, Undyed Braided	19
GD-794N	6-0	POLYSYN/POLYGLYCOLIC ACID, Undyed Braided	19
JA-2123N	9-0	POLYPROPYLENE, Blue Monofilament	54
JA-2200N	5-0	POLYPROPYLENE, Blue Monofilament	52
JA-2201N	4-0	POLYPROPYLENE, Blue Monofilament	52
JA-2202N	3-0	POLYPROPYLENE, Blue Monofilament	52
JA-2438N	5-0	POLYPROPYLENE, Blue Monofilament	52
JA-2439N	3-0	POLYPROPYLENE, Blue Monofilament	52
JA-2440N	6-0	POLYPROPYLENE, Blue Monofilament	52
JA-2442N	6-0	POLYPROPYLENE, Blue Monofilament	52
JA-2443N	5-0	POLYPROPYLENE, Blue Monofilament	52
JA-2468N	7-0	POLYPROPYLENE, Blue Monofilament	52
JA-2528N	10-0	POLYPROPYLENE, Blue Monofilament	52
JA-2529N	10-0	POLYPROPYLENE, Blue Monofilament	52
JA-2558N	9-0	POLYPROPYLENE, Blue Monofilament	52

PRODUCT INDEX

Suture

CODE	SIZE	MATERIAL	PAGE NUMBER
JA-2559N	10-0	POLYPROPYLENE, Blue Monofilament	52
JA-2560N	10-0	POLYPROPYLENE, Blue Monofilament	51
JA-2625N	9-0	POLYPROPYLENE, Blue Monofilament	51
JA-2775N	8-0	POLYPROPYLENE, Blue Monofilament	54
JC-1227D	5-0	POLYPROPYLENE, Blue Monofilament	53
JC-1229D	4-0	POLYPROPYLENE, Blue Monofilament	53
JC-1229N	4-0	POLYPROPYLENE, Blue Monofilament	53
JC-1231N	3-0	POLYPROPYLENE, Blue Monofilament	53
JC-1235D	3-0	POLYPROPYLENE, Blue Monofilament	53
JC-1235N	3-0	POLYPROPYLENE, Blue Monofilament	53
JC-1236D	3-0	POLYPROPYLENE, Blue Monofilament	53
JC-1239N	3-0	POLYPROPYLENE, Blue Monofilament	53
JC-1241D	2-0	POLYPROPYLENE, Blue Monofilament	53
JC-1249N	2-0	POLYPROPYLENE, Blue Monofilament	54
JC-1313N	0	POLYPROPYLENE, Blue Monofilament	54
JC-1712N	6-0	POLYPROPYLENE, Blue Monofilament	53
JC-1713N	5-0	POLYPROPYLENE, Blue Monofilament	53
JC-1782N	0	POLYPROPYLENE, Blue Monofilament	54
JD-8682	4-0	POLYPROPYLENE, Blue Monofilament	51
JD-8682S	4-0	POLYPROPYLENE, Blue Monofilament	51
JD-8686	5-0	POLYPROPYLENE, Blue Monofilament	51
JD-8686S	5-0	POLYPROPYLENE, Blue Monofilament	51
JD-8687	3-0	POLYPROPYLENE, Blue Monofilament	51
JD-8694	5-0	POLYPROPYLENE, Blue Monofilament	51
JD-8694DA	5-0	POLYPROPYLENE, Blue Monofilament	51
JD-8695	6-0	POLYPROPYLENE, Blue Monofilament	51
JD-8695S	6-0	POLYPROPYLENE, Blue Monofilament	51
JD-8697	6-0	POLYPROPYLENE, Blue Monofilament	51
JD-8697S	6-0	POLYPROPYLENE, Blue Monofilament	51
JD-8698	5-0	POLYPROPYLENE, Blue Monofilament	51
JD-8698S	5-0	POLYPROPYLENE, Blue Monofilament	51
JD-8699	4-0	POLYPROPYLENE, Blue Monofilament	51
JD-8699S	4-0	POLYPROPYLENE, Blue Monofilament	51
MA-426N	5-0	POLYSYN FA, Undyed Braided	17
MA-490N	5-0	POLYSYN FA, Undyed Braided	17
MA-494N	4-0	POLYSYN FA, Undyed Braided	17
MA-497N	3-0	POLYSYN FA, Undyed Braided	17
MA-496N	4-0	POLYSYN FA, Undyed Braided	17
MC-214N	4-0	POLYSYN FA, Undyed Braided	18
MC-422N	4-0	POLYSYN FA, Undyed Braided	17
MC-442N	3-0	POLYSYN FA, Undyed Braided	17
MC-456N	3-0	POLYSYN FA, Undyed Braided	17
MC-492N	4-0	POLYSYN FA, Undyed Braided	17
MC-493N	3-0	POLYSYN FA, Undyed Braided	17
MD-834N	5-0	POLYSYN FA, Undyed Braided	18
NC-315N	5-0	PCL, Violet Monofilament	30
NC-316N	3-0	PCL, Violet Monofilament	30
NC-317N	2-0	PCL, Violet Monofilament	30
NC-332N	3-0	PCL, Violet Monofilament	30
NC-333N	2-0	PCL, Violet Monofilament	30

Suture

CODE	SIZE	MATERIAL	PAGE NUMBER
NC-339N	2-0	PCL, Violet Monofilament	30
NC-340N	0	PCL, Violet Monofilament	30
NC-341N	1	PCL, Violet Monofilament	30
NC-397N	4-0	PCL, Violet Monofilament	29
NC-398N	3-0	PCL, Violet Monofilament	29
NC-466N	2-0	PCL, Violet Monofilament	29
NC-468N	1	PCL, Violet Monofilament	29
QD-489N	6-0	PCL, Clear Monofilament	29
QD-490N	5-0	PCL, Clear Monofilament	29
QD-492N	6-0	PCL, Clear Monofilament	29
QD-493N	5-0	PCL, Clear Monofilament	29
QD-494N	4-0	PCL, Clear Monofilament	29
QD-495N	5-0	PCL, Clear Monofilament	29
QD-496N	4-0	PCL, Clear Monofilament	29
QD-497N	3-0	PCL, Clear Monofilament	29
QD-507N	4-0	PCL, Clear Monofilament	29
QD-682N	4-0	PCL, Clear Monofilament	29
QD-683N	3-0	PCL, Clear Monofilament	29
YD-463N	5-0	Violet Monofilament	27
YD-464N	4-0	Violet Monofilament	27
YD-489N	6-0	Undyed, Monofilament	27
YD-490N	5-0	Undyed, Monofilament	27
YD-492N	6-0	Undyed, Monofilament	27
YD-493N	5-0	Undyed, Monofilament	27
YD-494N	4-0	Undyed, Monofilament	27
YD-495N	5-0	Undyed, Monofilament	27
YD-496N	4-0	Undyed, Monofilament	27
YD-497N	3-0	Undyed, Monofilament	27
YD-503N	5-0	Undyed, Monofilament	27
YD-504N	4-0	Undyed, Monofilament	27
YD-513N	4-0	Violet Monofilament	27
YD-682N	4-0	Undyed, Monofilament	27
YD-936N	3-0	Undyed, Monofilament	27
YP-463N	5-0	Violet Monofilament	27
YP-464N	4-0	Violet Monofilament	27
YP-489N	6-0	Undyed, Monofilament	27
YP-490N	5-0	Undyed, Monofilament	27
YP-492N	6-0	Undyed, Monofilament	27
YP-493N	5-0	Undyed, Monofilament	27
YP-494N	4-0	Undyed, Monofilament	27
YP-495N	5-0	Undyed, Monofilament	28
YP-496N	4-0	Undyed, Monofilament	28
YP-497N	3-0	Undyed, Monofilament	28
YP-513N	4-0	Violet Monofilament	28
YP-822N	5-0	Undyed, Monofilament	28
YP-823N	4-0	Undyed, Monofilament	28
YP-844N	5-0	Undyed, Monofilament	28
YP-845N	4-0	Undyed, Monofilament	28
YT-432N	6-0	Undyed, Monofilament	28
YT-433N	5-0	Undyed, Monofilament	28
YT-434N	4-0	Undyed, Monofilament	28

LOOK™ Suture Spools / Non-Sterile

CODE	SIZE	MATERIAL	PAGE NUMBER
SP102	6-0	SILK, Black Braided on Spools, 25 yards	49
SP103	5-0	SILK, Black Braided on Spools, 25 yards	49
SP104	4-0	SILK, Black Braided on Spools, 25 yards	49
SP105	3-0	SILK, Black Braided on Spools, 25 yards	49
SP106	2-0	SILK, Black Braided on Spools, 25 yards	49
SP114	6-0	SILK, Black Braided on Spools, 100 yards	49
SP115	5-0	SILK, Black Braided on Spools, 100 yards	49
SP116	4-0	SILK, Black Braided on Spools, 100 yards	49
SP117	3-0	SILK, Black Braided on Spools, 100 yards	49
SP118	2-0	SILK, Black Braided on Spools, 100 yards	49
SP119	0	SILK, Black Braided on Spools, 100 yards	49
SP120	1	SILK, Black Braided on Spools, 100 yards	49
SP187	3-0	NYLON, Black Monofilament on Spools, 100 yards	43
SP188	2-0	NYLON, Black Monofilament on Spools, 100 yards	43
SP189	0	NYLON, Black Monofilament on Spools, 100 yards	43
SP190	1	NYLON, Black Monofilament on Spools, 100 yards	43

Laboratory Packs / Non-Sterile

CODE	SIZE	MATERIAL	PAGE NUMBER
AK-0100	10-0	NYLON, Black Monofilament	57
AK-0101	10-0	NYLON, Black Monofilament	57
AK-0105	10-0	NYLON, Black Monofilament	57
AK-0106	10-0	NYLON, Black Monofilament	57
AK-0107	9-0	NYLON, Black Monofilament	57
AK-0109	9-0	NYLON, Black Monofilament	57
AK-2119	11-0	NYLON, Black Monofilament	57
AK-2120	10-0	NYLON, Black Monofilament	57
AK-2508	8-0	NYLON, Black Monofilament	57
AK-2546	8-0	NYLON, Black Monofilament	57

LOOK™ Umbilical Tape / Non-Sterile

CODE	SIZE	MATERIAL	PAGE NUMBER
UT 75	1/8 inch	Umbilical Tape, non-sterile	57
UT 76	1/4 inch	Umbilical Tape, non-sterile	57
UT 77	3/8 inch	Umbilical Tape, non-sterile	57

PRODUCT INDEX

Additional Products

CODE	PRODUCT DESCRIPTION	PAGE NUMBER
901	Bone Wax, ivory	58
902	Bone Wax, white	58
903	Bone Wax, white	58
82-0114	Video - "Microsurgical Repair of Rat Sciatic Nerve" - 1/2 VHS	58
82-0115	Video - "Microsurgical Repair of Rat Sciatic Nerve" - PAL - special order only	58
82-0116	Manual - "A Laboratory Manual for Microvascular and Microtubular Surgery"	58
82-0147	Manual - "Manual of Experimental Muscle Flap and Organ Transplantation Models in Rats"	58
AK-9000	PracticePak™	58
82-0117	Basic Unit 100	58
82-0118	Basic Unit 101	58
82-0119	Basic Unit 102	58
82-0120	Basic Unit 103	58
82-0135	Artificial Blood, arterial	58
82-0121	U Connector, tubing set	58

SURGICAL SPECIALTIES CORPORATION PRODUCTS RETURN GOODS AND ALLOWANCE POLICY

(Effective January 1, 2008)

Authorization for the return of merchandise must be obtained from Surgical Specialties Corporation Customer Service Team by calling 877 991-1110 or 732 626-6466. Any used product must be returned in special packaging. Please contact Customer Service for shipment of a special Biohazard Packaging Kit for the return shipment of used product. Surgical Specialties Corporation will refuse any merchandise returned without an authorization number.

ANY REQUESTS FOR AUTHORIZATION MUST INCLUDE:

- A. Reason for the return: "Ordered in Error," "Shipped in Error," "Product Complaint," etc.
- B. Catalog number(s), quantity, and lot number of each box.
- C. Customer's purchase order number and/or Surgical Specialties Corporation invoice number.
- D. Customer's purchase price.

SPECIAL NOTE: *If a customer cannot provide a purchase order number or a Surgical Specialties Corporation invoice number for the returned merchandise, then credit allowances will be based on previous purchase price history.*

MERCHANDISE THAT WILL NOT BE ACCEPTED:

- A. Merchandise ordered on "Special Order" or "Custom Product" basis.
- B. Merchandise not in standard packaging.
- C. Products not listed in the current Price List or obsoleted/discontinued products.
- D. Merchandise damaged by common carrier, (i.e., Truck, UPS, Parcel Post). Claim must be made against carrier.

ALL CLAIMS FOR SHORT SHIPMENTS:

- A. Must be communicated to Surgical Specialties Corporation Customer Service Team, via telephone or fax, within 30 days from receipt of goods or the claim will not be honored.

PRODUCT EVALUATION SAMPLES:

- A. Surgical Specialties Corporation will guarantee a 100% refund of the purchase price to the end-user customer for any product purchased on an initial evaluation order, if that product does not perform to your current standards. At least 50% of the original contents of the box must be provided to receive this refund. Contact Surgical Specialties Corporation Customer Service Team at 800 523-3332 or 610 404-1000 for additional details.

ALLOWANCE SCHEDULE FOR ACCEPTABLE STOCK RETURNS:

- | | | |
|----|---|---------------|
| A. | Saleable merchandise returned within 60 days of invoice date requiring no reprocessing..... | Full Credit |
| B. | Saleable merchandise returned after 60 days to one year of invoice date requiring no reprocessing..... | Cost Less 40% |
| C. | Saleable merchandise returned within 60 days of invoice date requiring reprocessing, repackaging, etc..... | Cost Less 40% |
| D. | Saleable merchandise returned after 60 days to one year of invoice date requiring reprocessing, repackaging, etc..... | Cost Less 60% |
| E. | Merchandise returned after one year from invoice date..... | No Credit |
| F. | Merchandise unsuitable for resale..... | No Credit |
| G. | Merchandise defective at time of receipt by customer..... | Full Credit |
| H. | Merchandise shipped in error by Surgical Specialties Corporation..... | Full Credit |

NOTES:

- A. Customer must prepay all freight charges on stock returns except for:
 1. Defective material.
 2. Merchandise shipped in error.
 Upon authorization by Surgical Specialties Customer Service Team, merchandise will be accepted freight collect.
- B. Returns from dealers/customers must be handled by contacting the Surgical Specialties Customer Service Team. These returns are subject to all of the above terms.

This policy constitutes the entire policy for Surgical Specialties Corporation and supersedes all prior return goods policies, whether written or oral, with

